

# BATHROOM

**P.WE.**

[PLAY WITH EVERYTHING]  
DESIGN HOUSE

PROJECT NAME:

- house

OWNER:

PROJECT DIRECTOR

**P.WE.**

[PLAY WITH EVERYTHING]  
DESIGN HOUSE

ARCHITECTS

เขมจิรา ณ นคร  
ภ-สถ 16584

INTERIOR DESIGNER

STRUCTURAL ENGINEERS

นฤตย์พงษ์ เรืองวัฒนานนท์  
ภย.55929

ELECTRICAL ENGINEERS

SANITARY ENGINEERS

PROJECT MANAGER

REVISION

REV.	DATE	REVISION RECORD
01	26/06/2016	

DRAWING TITLE:

CHECKED BY:

DRAWN BY:

เขมจิรา ณ นคร ภ-สถ 16584

SCALE: 1 : 20 DATE: 10/08/2016

DRAWING NO. TOTAL

-This drawing shall not be used for construction unless signed "approved".



PROJECT NAME:

- house

OWNER:

PROJECT DIRECTOR

**P.WE.**

[PLAY WITH EVERYTHING]  
DESIGN HOUSE

ARCHITECTS

เชมจิรา ณ นคร  
ภ-สถ 16584

INTERIOR DESIGNER

STRUCTURAL ENGINEERS

นฤตย์พงษ์ เรืองวัฒนานนท์  
ภย.55929  
ELECTRICAL ENGINEERS

SANITARY ENGINEERS

PROJECT MANAGER

REVISION

REV.	DATE	REVISION RECORD
01	26/06/2016	

DRAWING TITLE:

TOILET DETAIL-1

CHECKED BY:

DRAWN BY:

เชมจิรา ณ นคร ภ-สถ 16584

SCALE:

1:50

DATE:

10/08/2016

DRAWING NO.

A-10

TOTAL

-This drawing shall not be used for construction unless signed "approved".

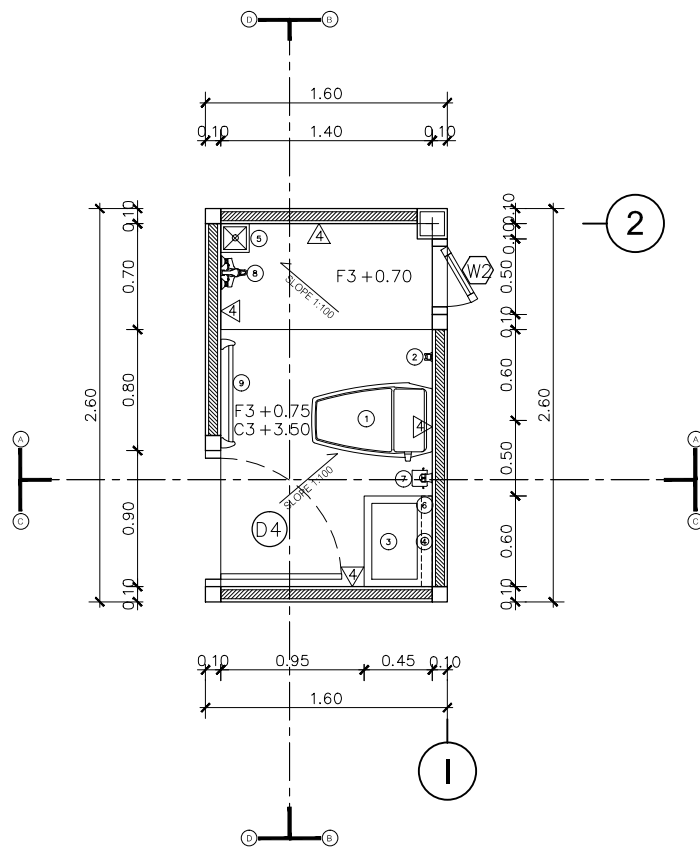

BATHROOM 2 ± FLOOR 1

SCALE

1:50

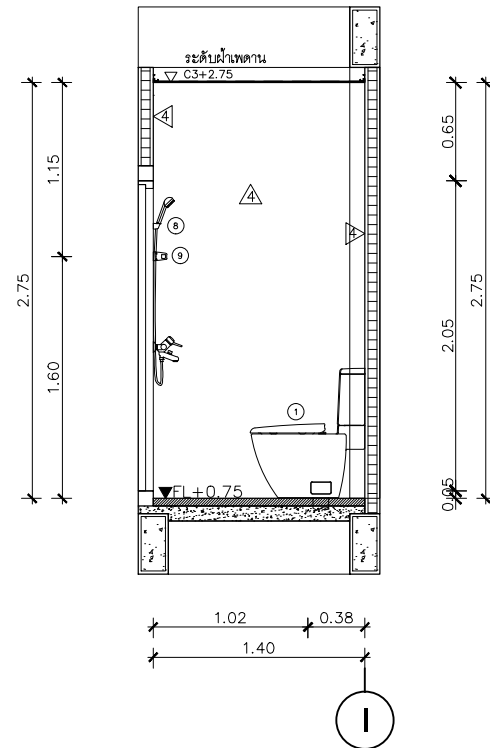
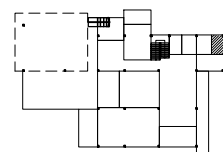

SECTION A

SCALE 1:50

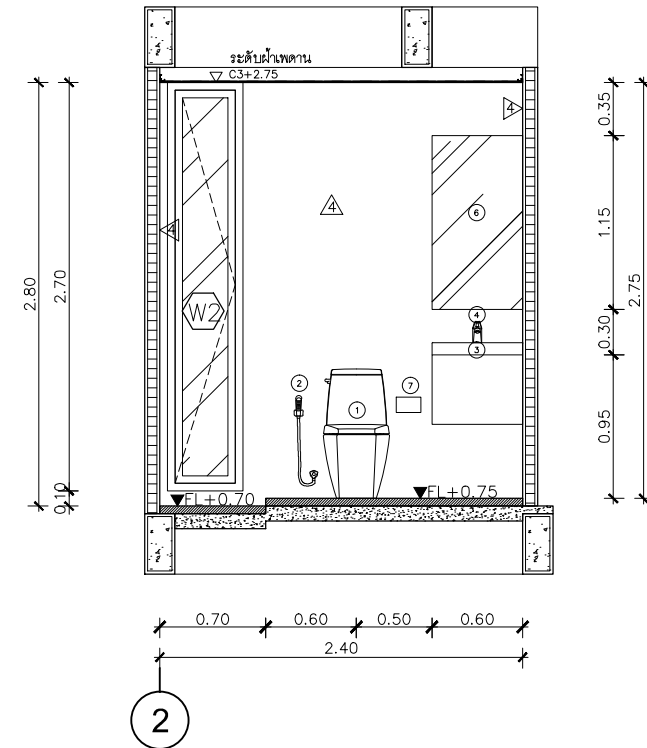

SECTION B

SCALE 1:50

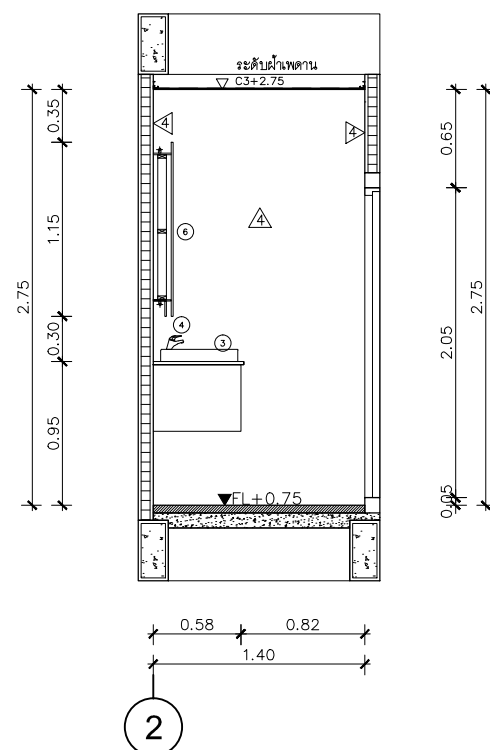

SECTION C

SCALE 1:50

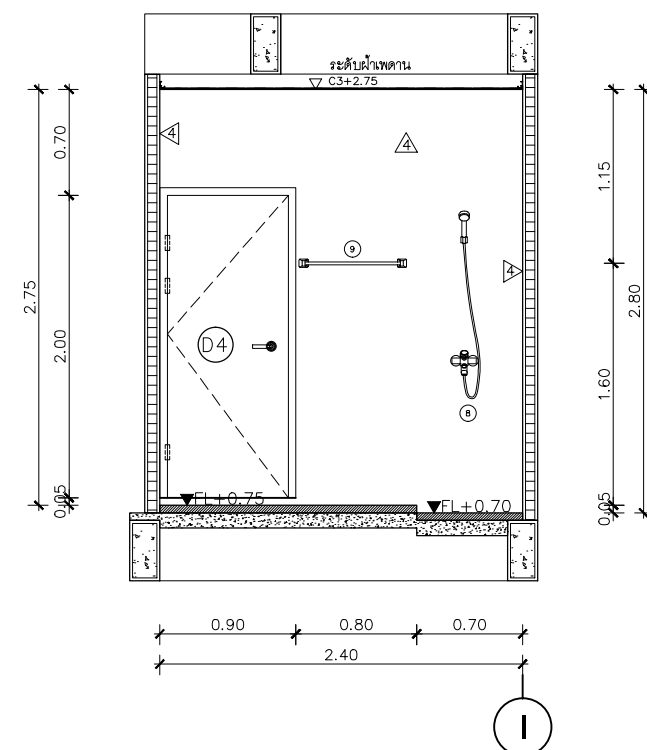

SECTION D

SCALE 1:50

เฟอร์นิเจอร์			
ลำดับที่	สัญลักษณ์	คำอธิบาย	รายละเอียด
1	①	สุขภัณฑ์	
2	②	สายชำระ	
3	③	อ่างล้างหน้า	
4	④	ก๊อกอ่างล้างหน้า	
5	⑤	ฝาท่อระบายน้ำ	
6	⑥	กระจก	
7	⑦	กล่องใส่กระดาษชำระ	
8	⑧	ฝักบัว	
9	⑨	ราวแขวนผ้า	
10	△	ผนังกระเบื้อง	

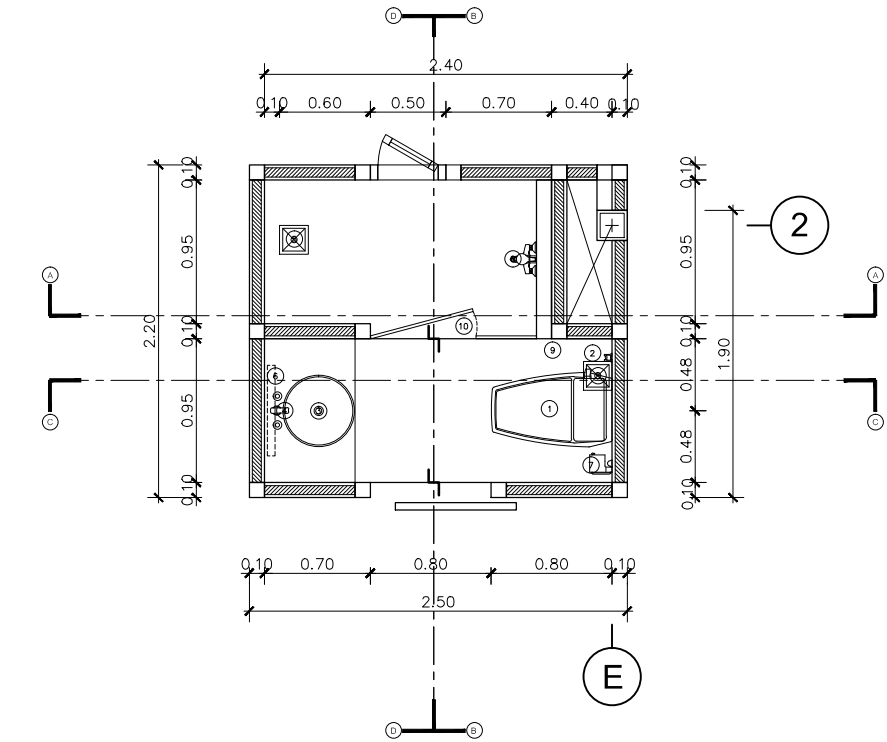

BATHROOM 3 ± FLOOR 2

SCALE 1:50

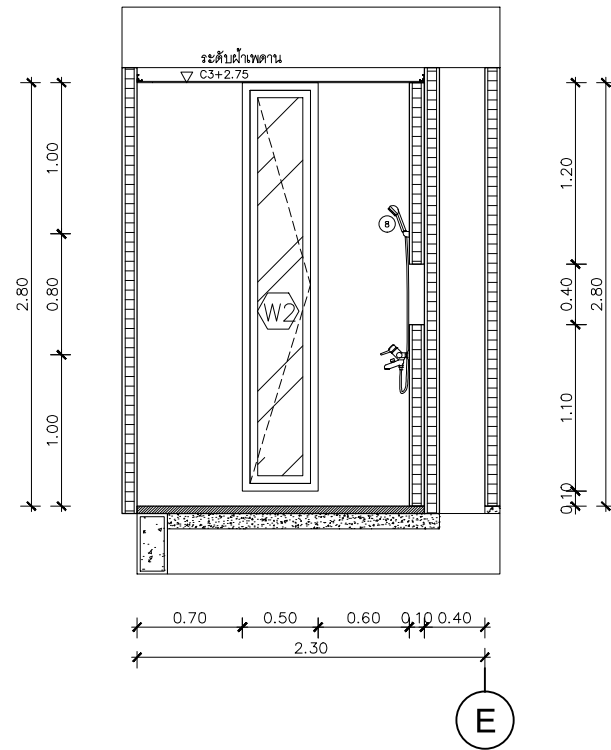
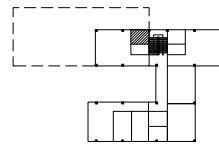

SECTION A  
SCALE 1:50

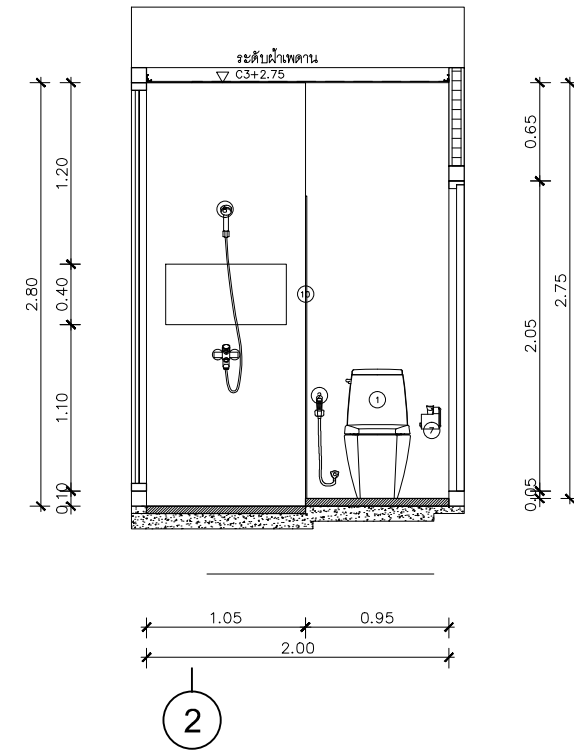

SECTION B  
SCALE 1:50

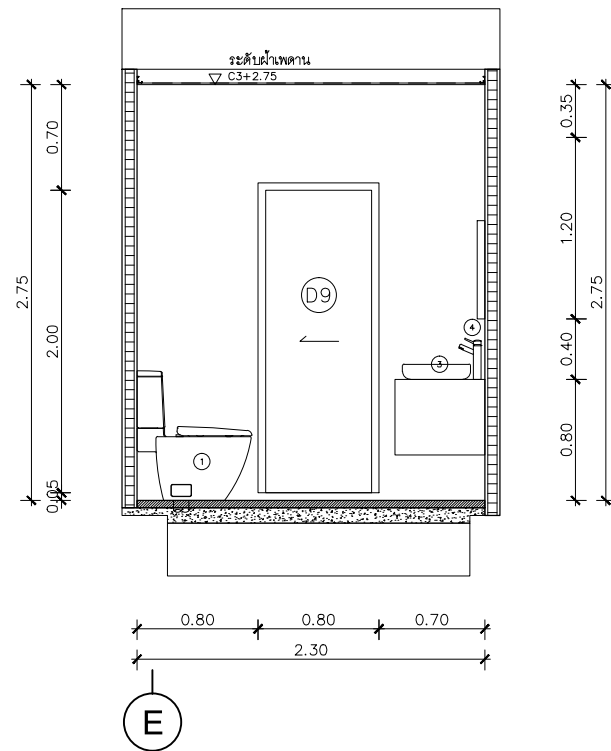

SECTION C  
SCALE 1:50

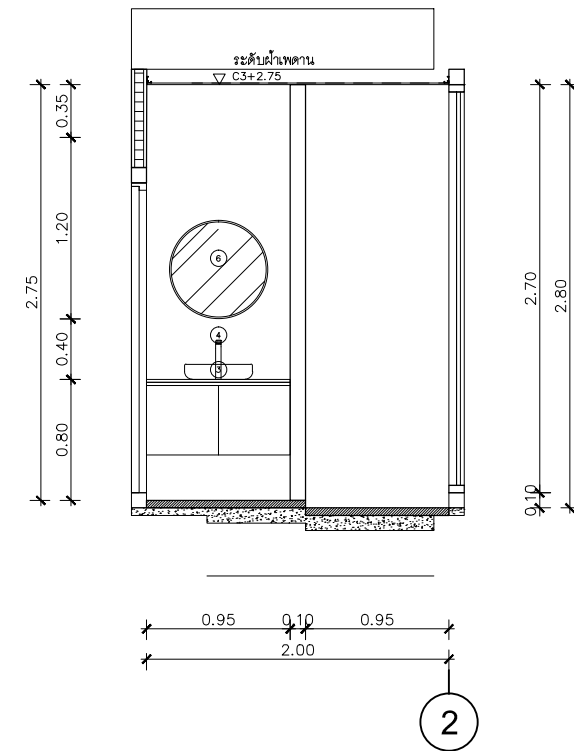

SECTION D  
SCALE 1:50

เฟอร์นิเจอร์			
ลำดับที่	สัญลักษณ์	คำอธิบาย	รายละเอียด
1	①	สุขภัณฑ์	
2	②	สายชำระ	
3	③	อ่างล้างหน้า	
4	④	ก๊อกอ่างล้างหน้า	
5	⑤	ฝาท่อระบายน้ำ	
6	⑥	กระจก	
7	⑦	กล่องใส่กระดาษชำระ	
8	⑧	ฝักบัว	
9	⑨	ราวแขวนผ้า	
10	⑩	กระจกกันชื้นเปียก	
11	△	ผนังกระเบื้อง	

**P.WE.**  
[PLAY WITH EVERYTHING]  
DESIGN HOUSE

PROJECT NAME:  
**- house**

OWNER:

PROJECT DIRECTOR

**P.WE.**  
[PLAY WITH EVERYTHING]  
DESIGN HOUSE

ARCHITECTS

เฉลิมจิรา ณ นคร  
ภ-สถ 16584

INTERIOR DESIGNER

STRUCTURAL ENGINEERS

นฤตย์พงษ์ เรืองวัฒนานนท์  
ภย.55929

ELECTRICAL ENGINEERS

SANITARY ENGINEERS

PROJECT MANAGER

REVISION

REV.	DATE	REVISION RECORD
01	26/06/2016	

DRAWING TITLE:

**TOILET DETAIL-1**

CHECKED BY:

DRAWN BY:  
เฉลิมจิรา ณ นคร ภ-สถ 16584

SCALE: 1:50 DATE: 10/08/2016

DRAWING NO. A-10 TOTAL

-This drawing shall not be used for construction unless signed "approved".

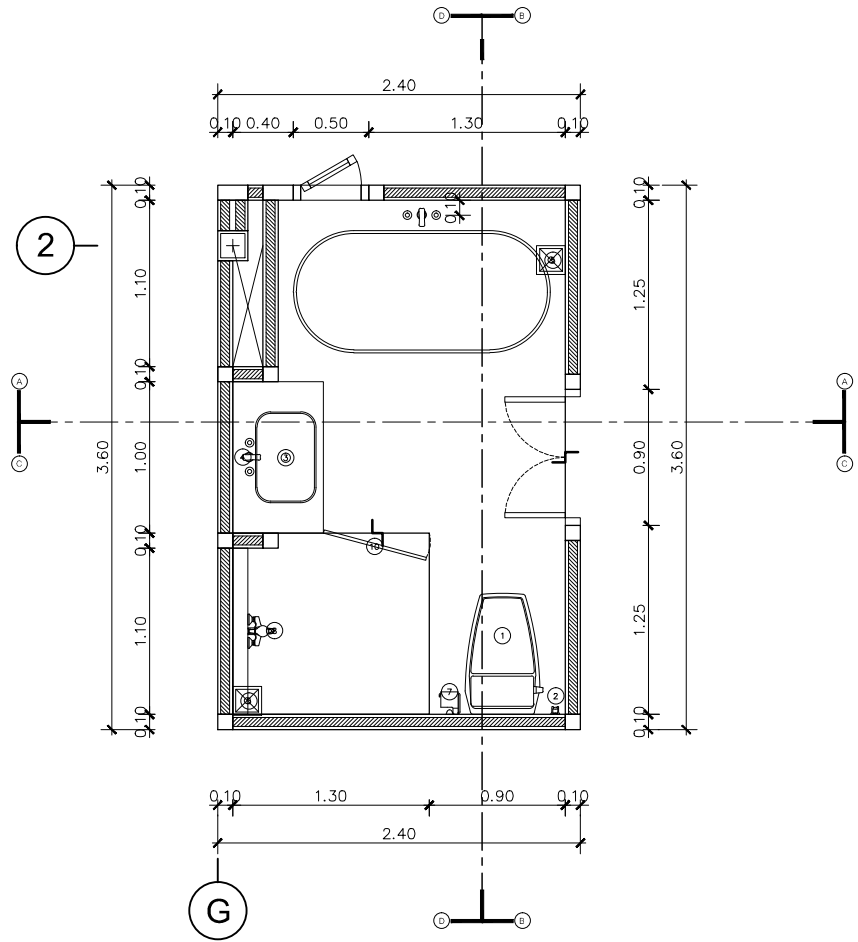

BATHROOM 4 ± FLOOR 2

SCALE 1:50

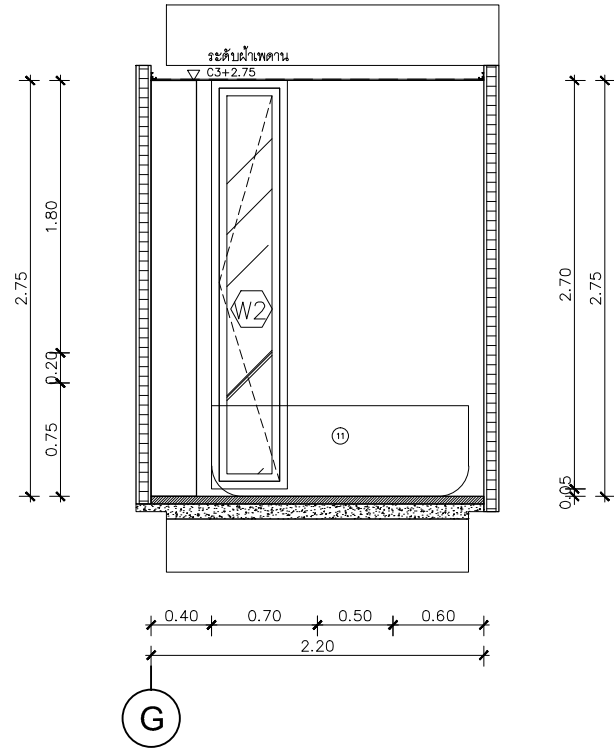
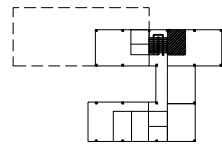

SECTION A  
SCALE 1:50

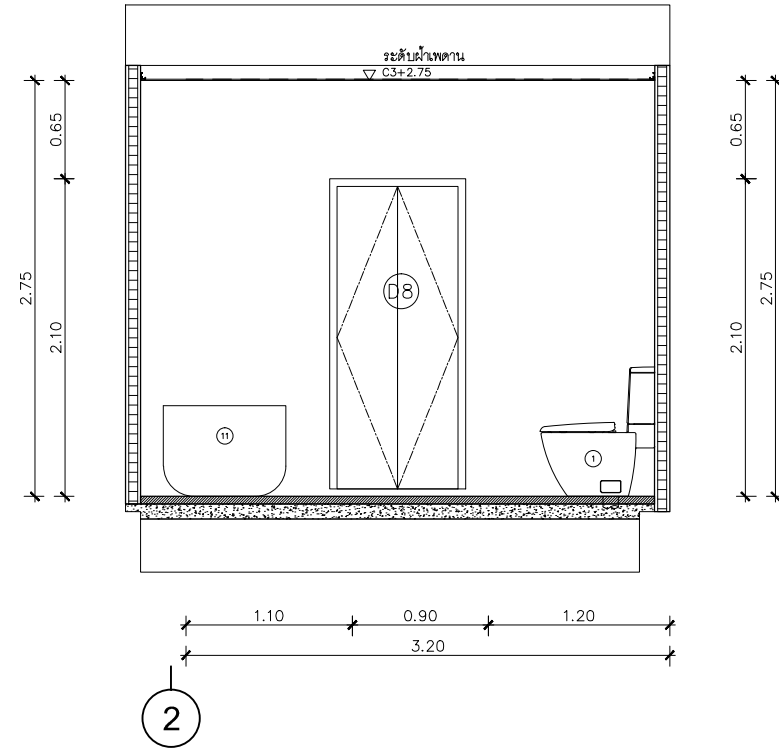

SECTION B  
SCALE 1:50

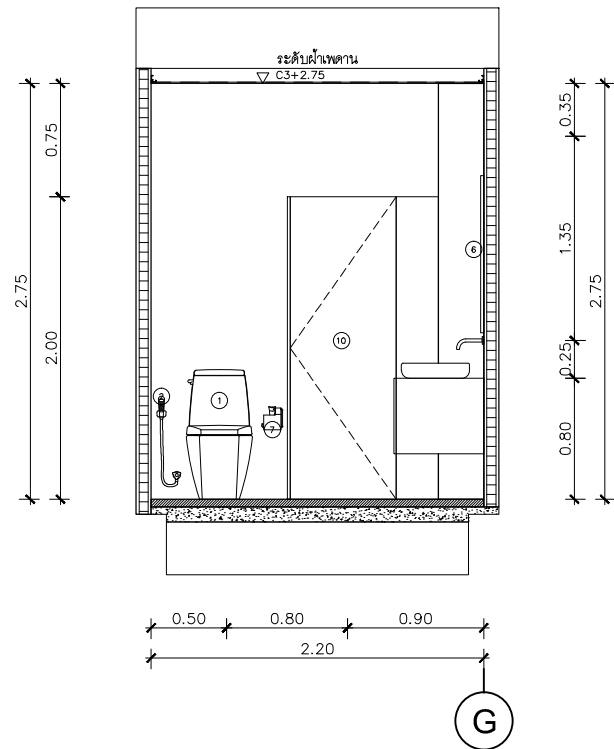

SECTION C  
SCALE 1:50

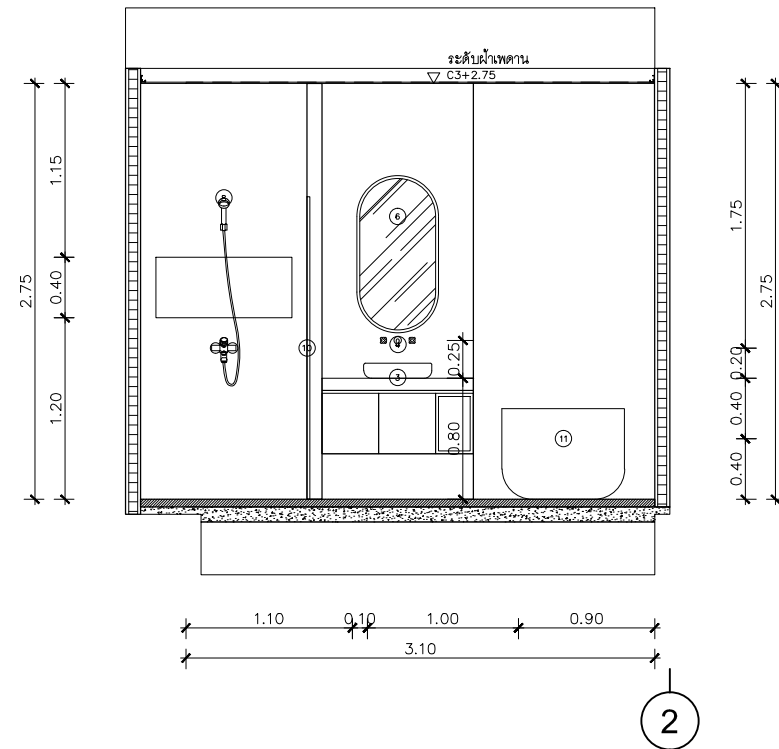

SECTION D  
SCALE 1:50

**P.WE.**  
[PLAY WITH EVERYTHING]  
DESIGN HOUSE

PROJECT NAME:  
**- house**

OWNER:

PROJECT DIRECTOR

**P.WE.**  
[PLAY WITH EVERYTHING]  
DESIGN HOUSE

ARCHITECTS

เชมจิรา ณ นคร  
ภ-สถ 16584

INTERIOR DESIGNER

STRUCTURAL ENGINEERS

นฤตย์พงษ์ เรืองวัฒนานนท์  
ภย.55929

ELECTRICAL ENGINEERS

SANITARY ENGINEERS

PROJECT MANAGER

REVISION

REV.	DATE	REVISION RECORD
01	26/06/2016	

DRAWING TITLE:

**TOILET DETAIL-1**

CHECKED BY:

DRAWN BY:  
เชมจิรา ณ นคร ภ-สถ 16584

SCALE: 1:50 DATE: 10/08/2016

DRAWING NO. A-10 TOTAL

-This drawing shall not be used for construction unless signed "approved".

PROJECT NAME:

- house

OWNER:

PROJECT DIRECTOR

**P.WE.**

[PLAY WITH EVERYTHING]  
DESIGN HOUSE

ARCHITECTS

เชมจิรา ณ นคร  
ภ-สถ 16584

INTERIOR DESIGNER

STRUCTURAL ENGINEERS

นฤตย์พงษ์ เรืองวัฒนานนท์  
ภย.55929  
ELECTRICAL ENGINEERS

SANITARY ENGINEERS

PROJECT MANAGER

REVISION

REV.	DATE	REVISION RECORD
01	26/06/2016	

DRAWING TITLE:

TOILET DETAIL-1

CHECKED BY:

DRAWN BY:

เชมจิรา ณ นคร ภ-สถ 16584

SCALE:

1:50

DATE:

10/08/2016

DRAWING NO.

A-10

TOTAL

-This drawing shall not be used for construction unless signed "approved".

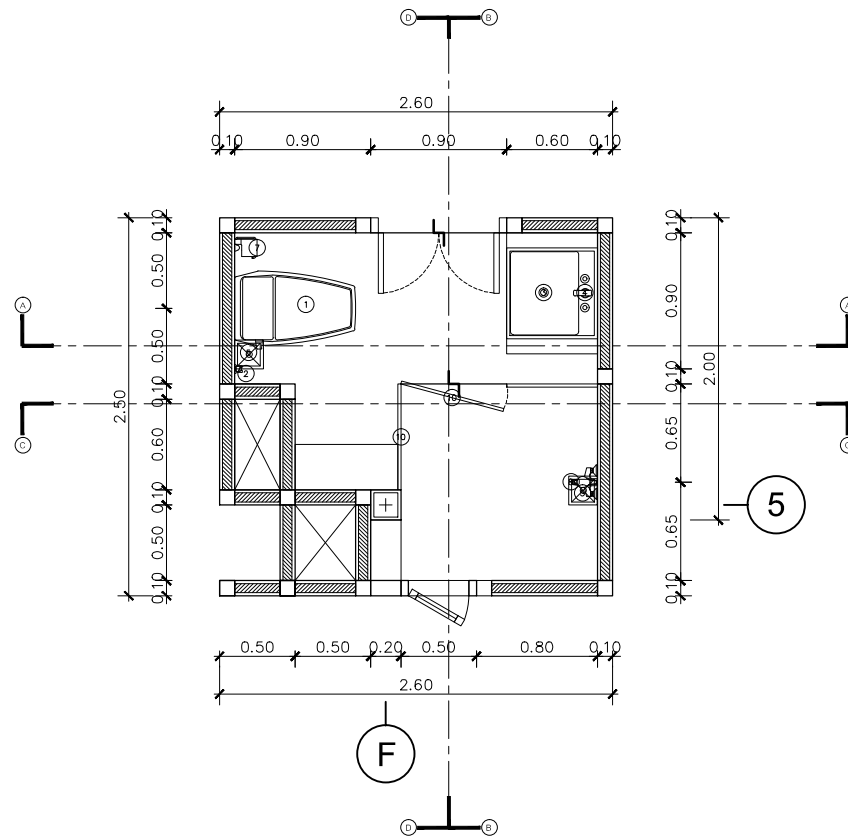

BATHROOM 5 ± FLOOR 2

SCALE 1:50

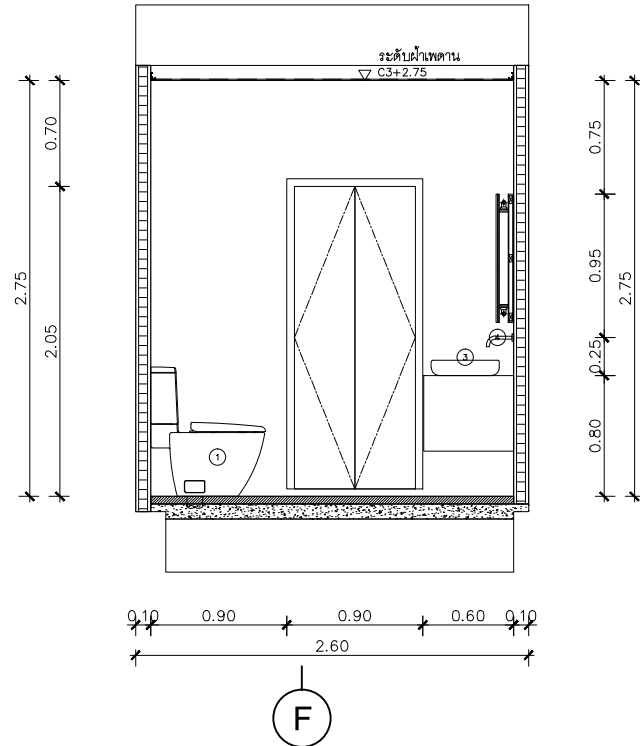

SECTION A  
SCALE 1:50

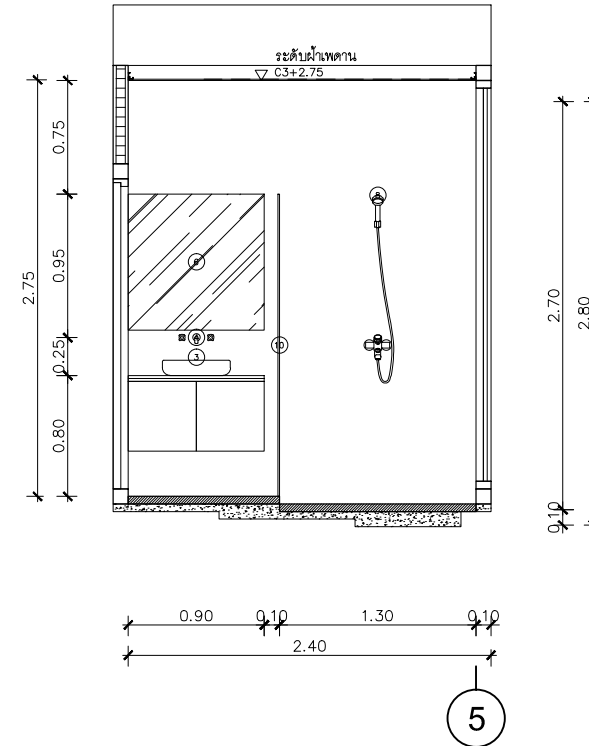

SECTION B  
SCALE 1:50

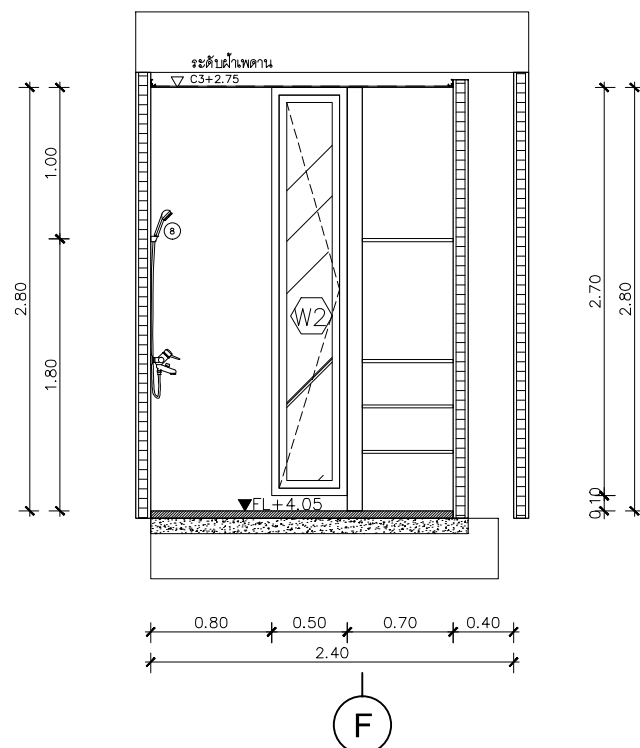

SECTION C  
SCALE 1:50

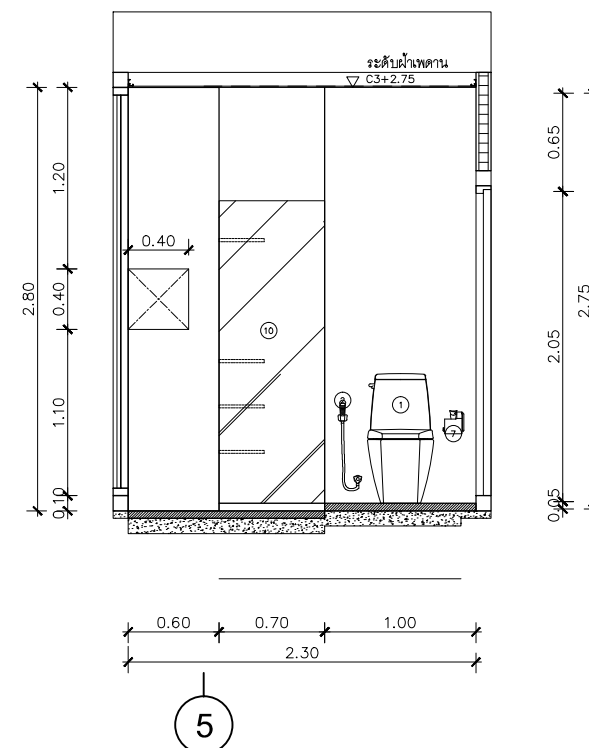

SECTION D  
SCALE 1:50

เฟอร์นิเจอร์			
ลำดับที่	สัญลักษณ์	คำอธิบาย	รายละเอียด
1	①	สุขภัณฑ์	
2	②	สายชำระ	
3	③	อ่างล้างหน้า	
4	④	ก๊อกอ่างล้างหน้า	
5	⑤	ฝาท่อระบายน้ำ	
6	⑥	กระจก	
7	⑦	กล่องใส่กระดาษชำระ	
8	⑧	ฝักบัว	
9	⑨	ราวแขวนผ้า	
10	⑩	กระจกกันชื้นเปียก	
11	△	ผนังกระเบื้อง	

PROJECT NAME:

- house

OWNER:

PROJECT DIRECTOR

**P.WE.**

[PLAY WITH EVERYTHING]  
DESIGN HOUSE

ARCHITECTS

เชมจิรา ณ นคร  
ภ-สถ 16584

INTERIOR DESIGNER

STRUCTURAL ENGINEERS

นฤตยพงษ์ เรืองวัฒนานนท์  
ภย.55929  
ELECTRICAL ENGINEERS

SANITARY ENGINEERS

PROJECT MANAGER

REVISION

REV.	DATE	REVISION RECORD
01	26/06/2016	

DRAWING TITLE:

TOILET DETAIL-1

CHECKED BY:

DRAWN BY:

เชมจิรา ณ นคร ภ-สถ 16584

SCALE:

1: 50

DATE:

10/08/2016

DRAWING NO.

A-10

TOTAL

-This drawing shall not be used for construction unless signed "approved".

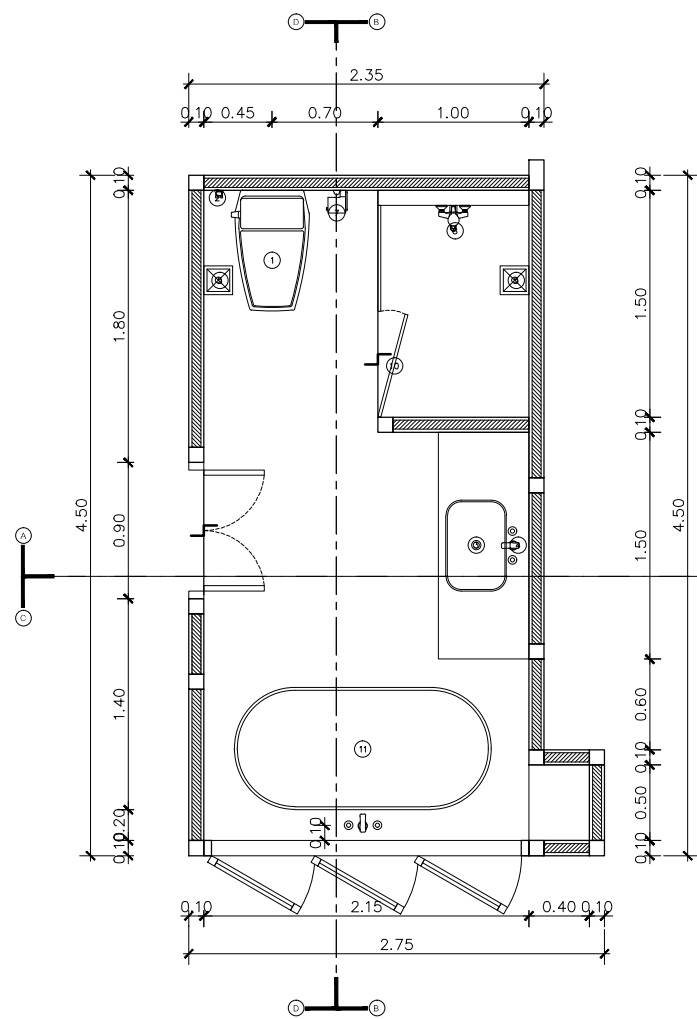

BATHROOM 6 (CHEE) ± FLOOR 2

SCALE 1: 50

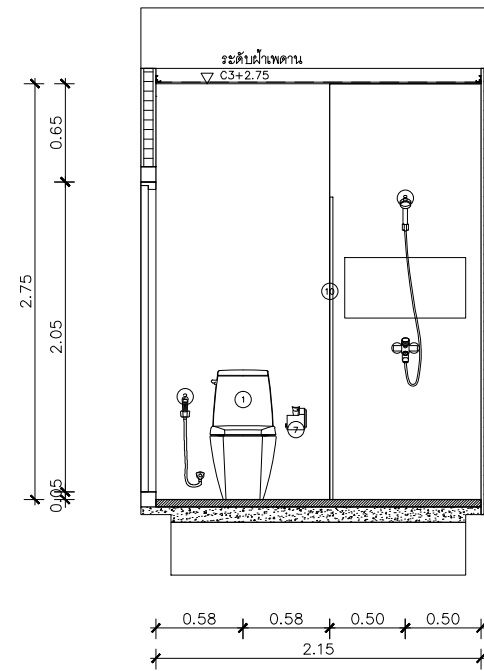
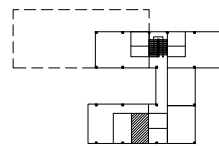

SECTION A  
SCALE 1: 50

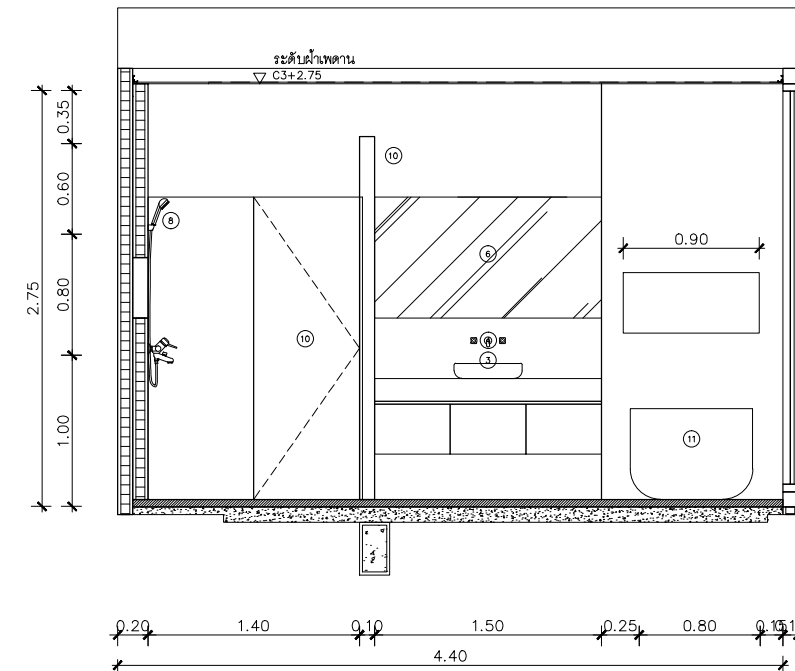
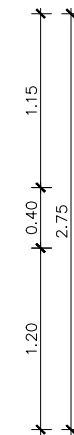

SECTION B  
SCALE 1: 50

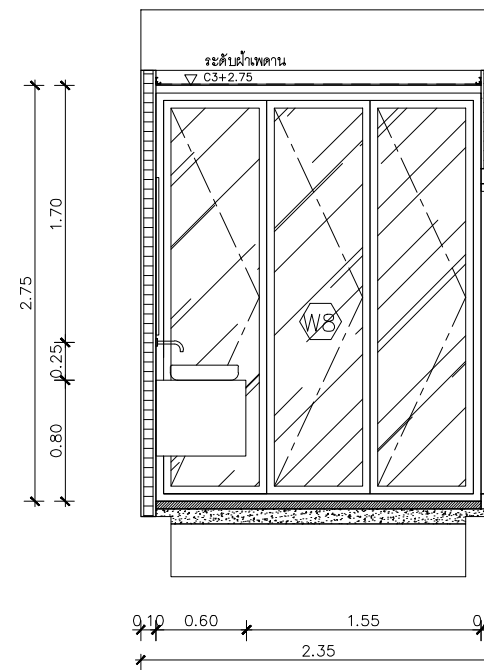
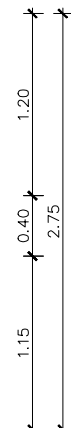

SECTION C  
SCALE 1: 50

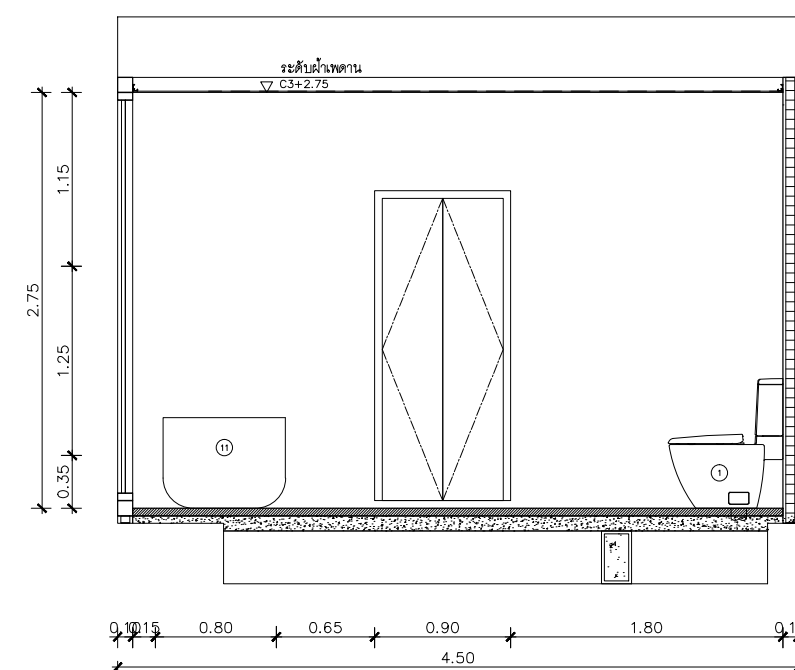
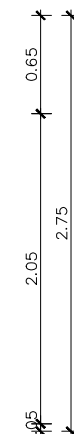

SECTION D  
SCALE 1: 50

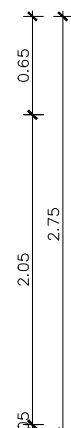

เฟอร์นิเจอร์			
ลำดับที่	สัญลักษณ์	คำอธิบาย	รายละเอียด
1	①	สุขภัณฑ์	
2	②	สายชำระ	
3	③	อ่างล้างหน้า	
4	④	ก๊อกอ่างล้างหน้า	
5	⑤	ฝาท่อระบายน้ำ	
6	⑥	กระจก	
7	⑦	กล่องใส่กระดาษชำระ	
8	⑧	ฝักบัว	
9	⑨	ราวแขวนผ้า	
10	⑩	กระจกกันชื้นเปียก	
11	⑪	อ่างอาบน้ำ	
12	⚠	ผนังกระเบื้อง	

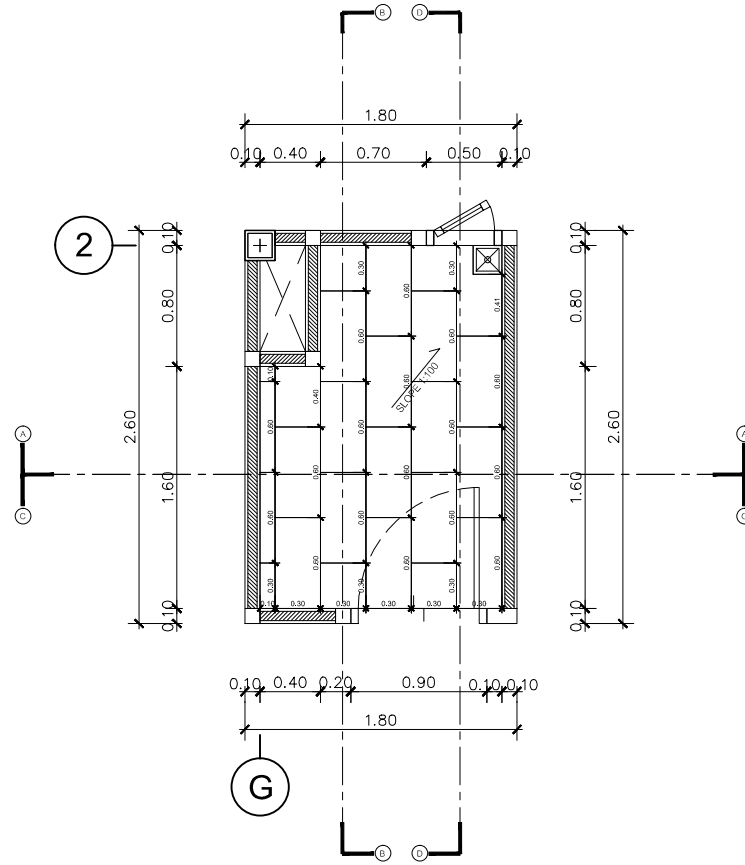

BATHROOM 1 ± FLOOR 1

SCALE 1:50

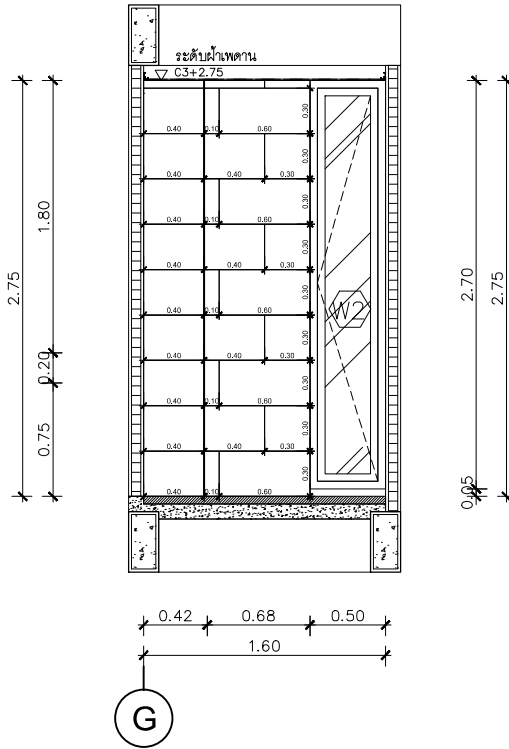
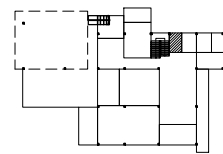

SECTION A  
SCALE 1:50

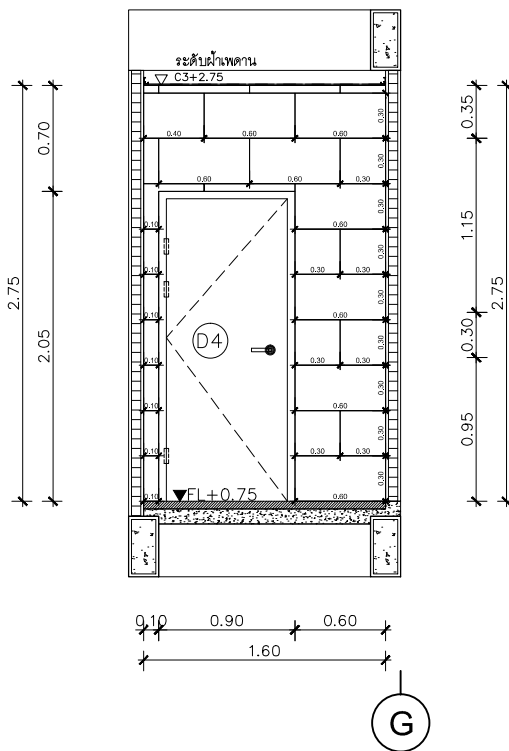

SECTION C  
SCALE 1:50

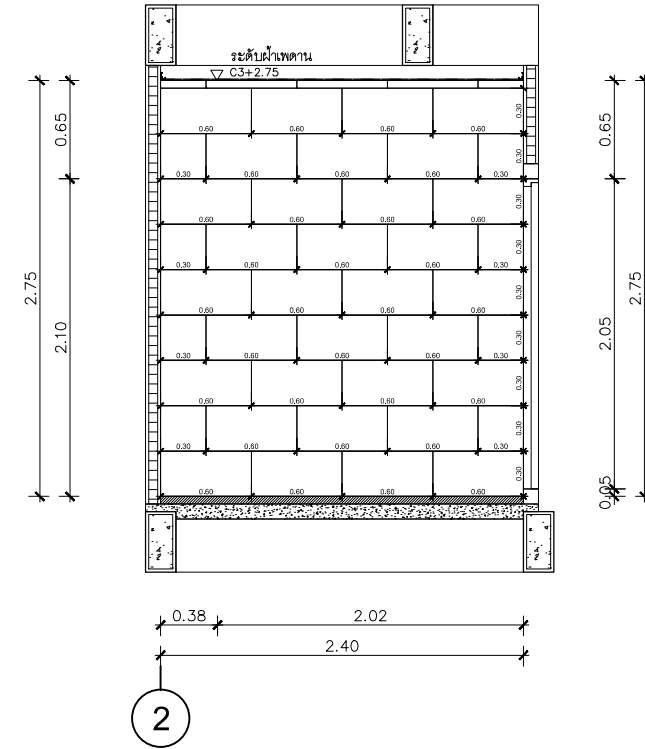

SECTION B  
SCALE 1:50

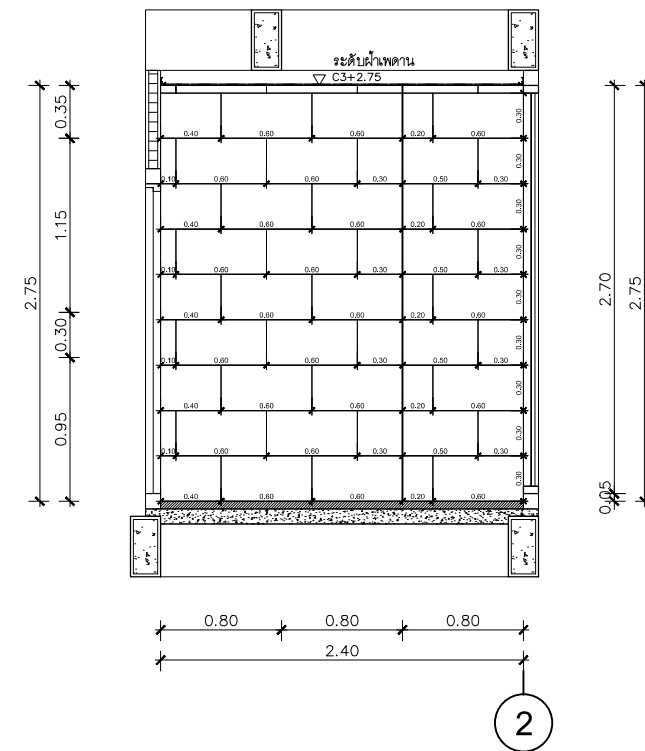

SECTION D  
SCALE 1:50

**P.WE.**  
[PLAY WITH EVERYTHING]  
DESIGN HOUSE

PROJECT NAME:  
**- house**

OWNER:

PROJECT DIRECTOR

**P.WE.**  
[PLAY WITH EVERYTHING]  
DESIGN HOUSE

ARCHITECTS

เชมจิรา ณ นคร  
ภ-สถ 16584

INTERIOR DESIGNER

STRUCTURAL ENGINEERS

นฤตย์พงษ์ เรืองวัฒนานนท์  
ภย.55929  
ELECTRICAL ENGINEERS

SANITARY ENGINEERS

PROJECT MANAGER

REVISION

REV.	DATE	REVISION RECORD
01	26/06/2016	

DRAWING TITLE:

**TOILET DETAIL-1**

CHECKED BY:

DRAWN BY:  
เชมจิรา ณ นคร ภ-สถ 16584

SCALE: **1:50** DATE: 10/08/2016

DRAWING NO. **A-10** TOTAL

-This drawing shall not be used for construction unless signed "approved".



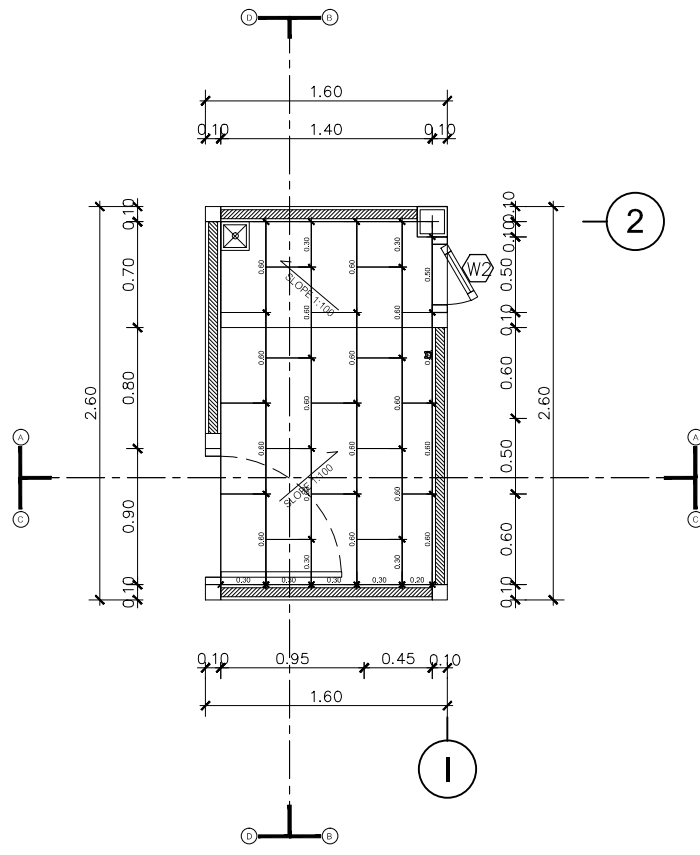

BATHROOM 2 ± FLOOR 1  
SCALE 1:50

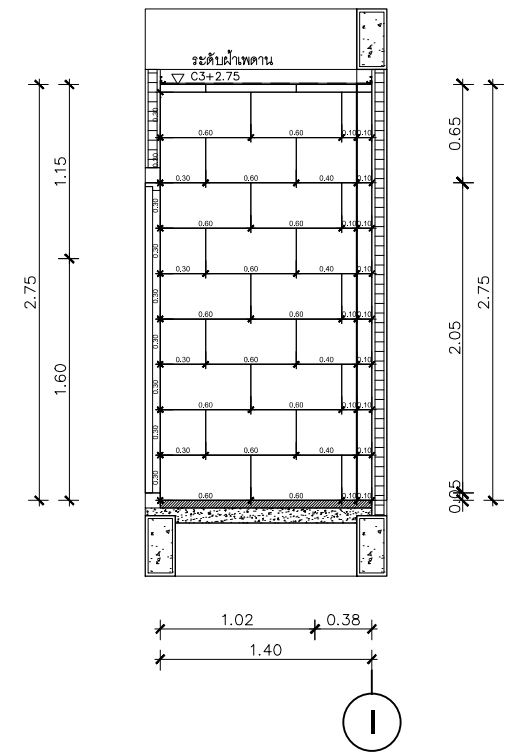
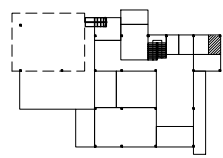

SECTION A  
SCALE 1:50

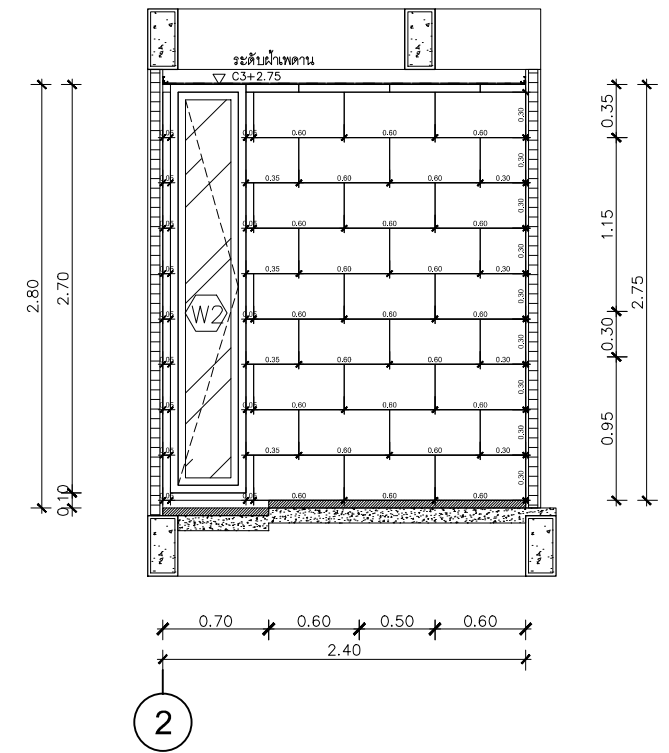

SECTION B  
SCALE 1:50

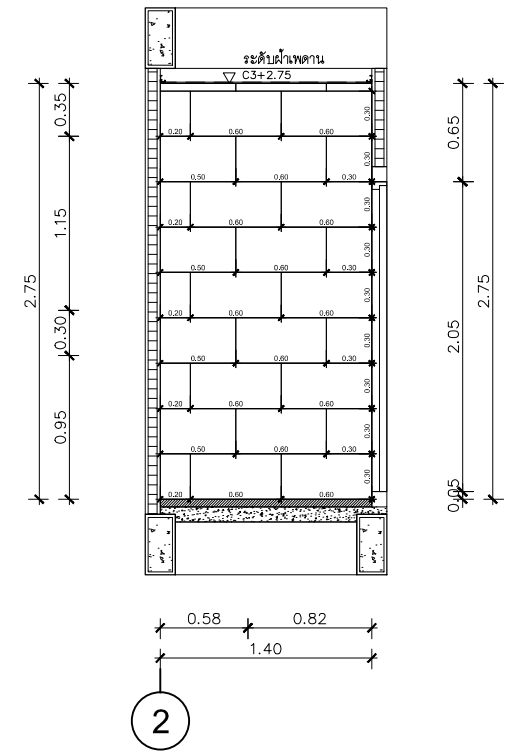

SECTION C  
SCALE 1:50

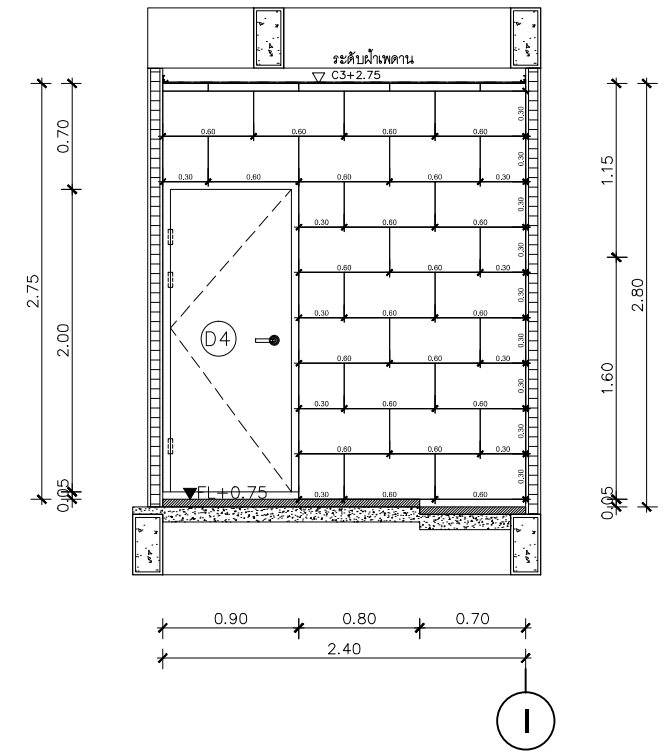

SECTION D  
SCALE 1:50

**P.WE.**  
[PLAY WITH EVERYTHING]  
DESIGN HOUSE

PROJECT NAME:  
**- house**

OWNER:

PROJECT DIRECTOR

**P.WE.**  
[PLAY WITH EVERYTHING]  
DESIGN HOUSE

ARCHITECTS

เชมจิรา ณ นคร  
ภ-สถ 16584

INTERIOR DESIGNER

STRUCTURAL ENGINEERS

นฤตย์พงษ์ เรืองวัฒนานนท์  
ภย.55929  
ELECTRICAL ENGINEERS

SANITARY ENGINEERS

PROJECT MANAGER

REVISION

REV.	DATE	REVISION RECORD
01	26/06/2016	

DRAWING TITLE:

**TOILET DETAIL-1**

CHECKED BY:

DRAWN BY:  
เชมจิรา ณ นคร ภ-สถ 16584

SCALE: **1:50** DATE: 10/08/2016

DRAWING NO. **A-10** TOTAL

-This drawing shall not be used for construction unless signed "approved".

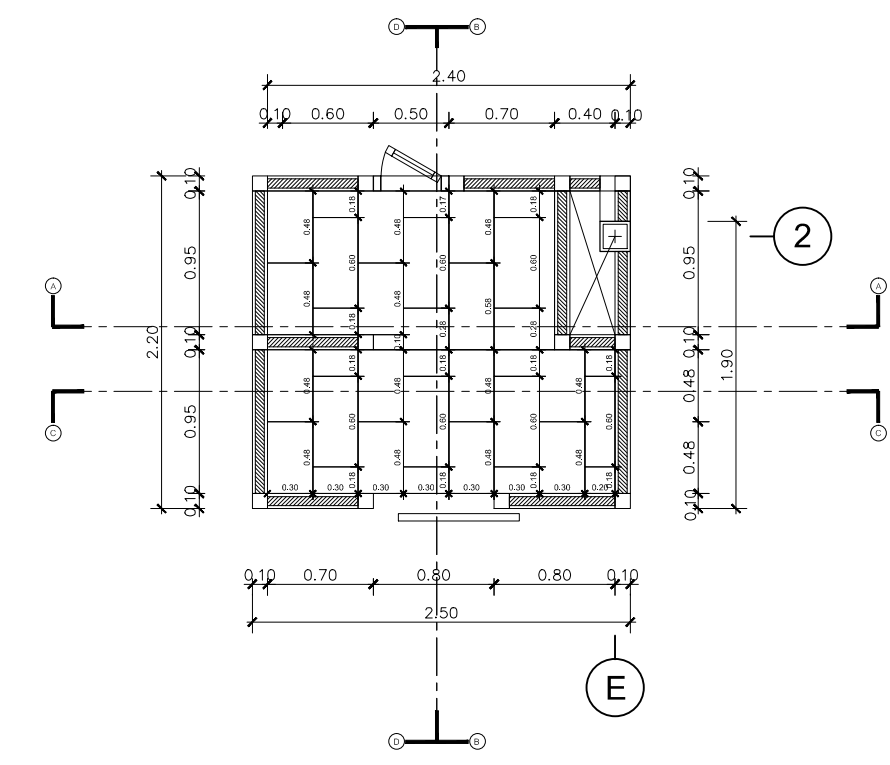

BATHROOM 3 ± FLOOR 2  
SCALE 1:50

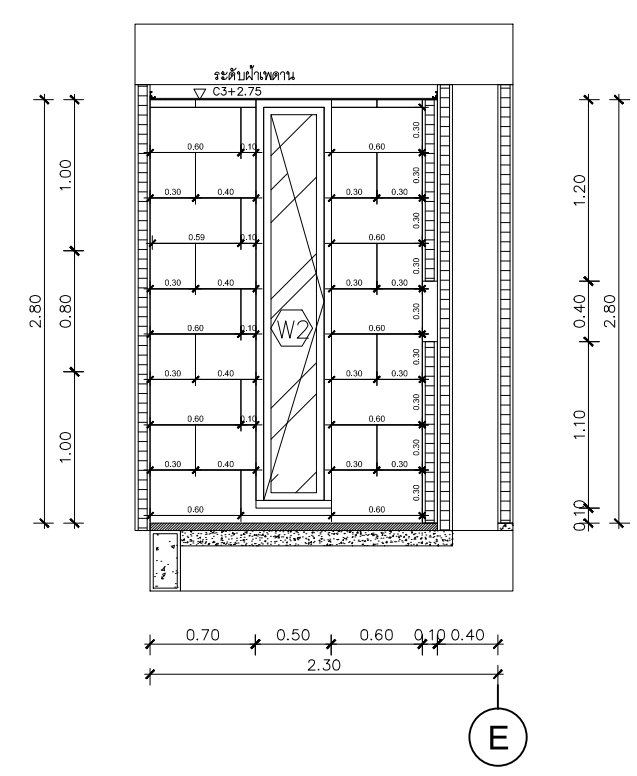
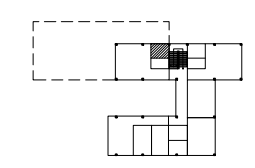

SECTION A  
SCALE 1:50

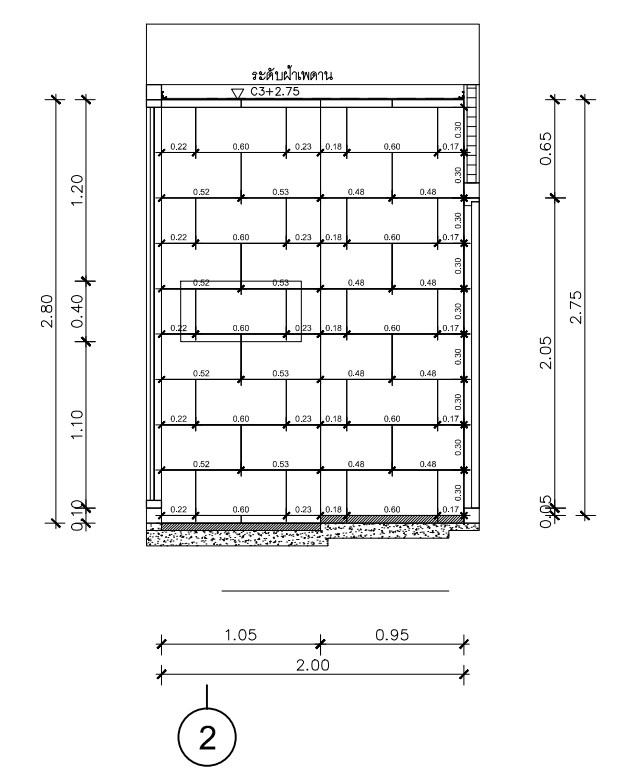

SECTION B  
SCALE 1:50

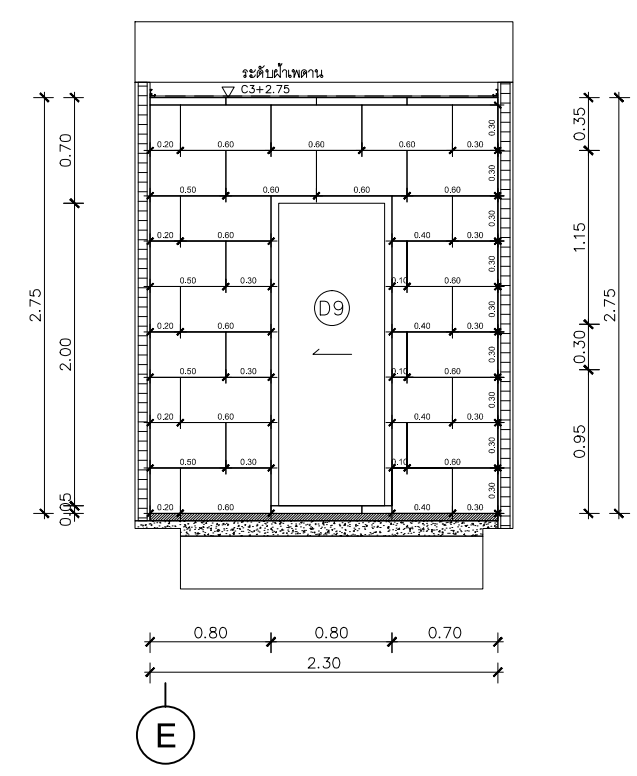

SECTION C  
SCALE 1:50

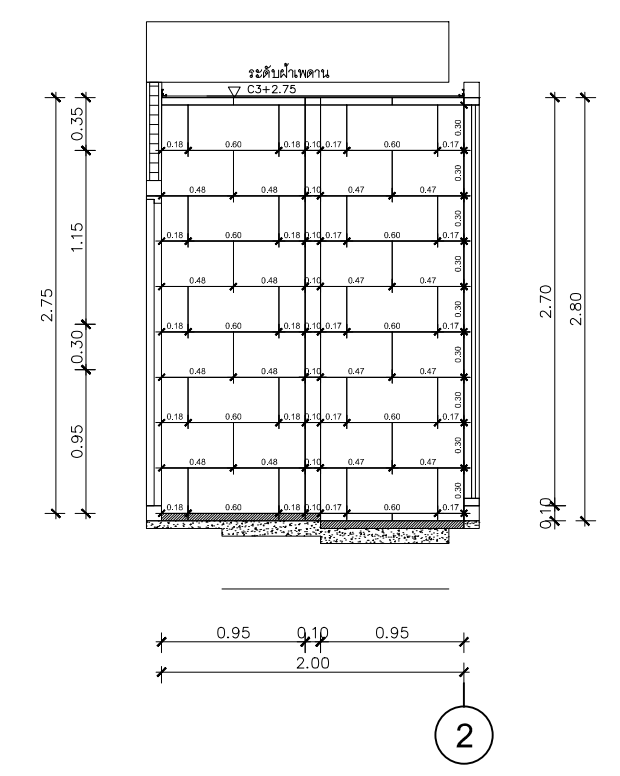

SECTION D  
SCALE 1:50

**P.WE.**  
[PLAY WITH EVERYTHING]  
DESIGN HOUSE

PROJECT NAME:  
**- house**

OWNER:

PROJECT DIRECTOR

**P.WE.**  
[PLAY WITH EVERYTHING]  
DESIGN HOUSE

ARCHITECTS

เชมจิรา ณ นคร  
ภ-สถ 16584

INTERIOR DESIGNER

STRUCTURAL ENGINEERS

นฤตย์พงษ์ เรืองวัฒนานนท์  
ภย.55929

ELECTRICAL ENGINEERS

SANITARY ENGINEERS

PROJECT MANAGER

REVISION

REV.	DATE	REVISION RECORD
01	26/06/2016	

DRAWING TITLE:

**TOILET DETAIL-1**

CHECKED BY:

DRAWN BY:  
เชมจิรา ณ นคร ภ-สถ 16584

SCALE: 1:50 DATE: 10/08/2016

DRAWING NO. A-10 TOTAL

-This drawing shall not be used for construction unless signed "approved".

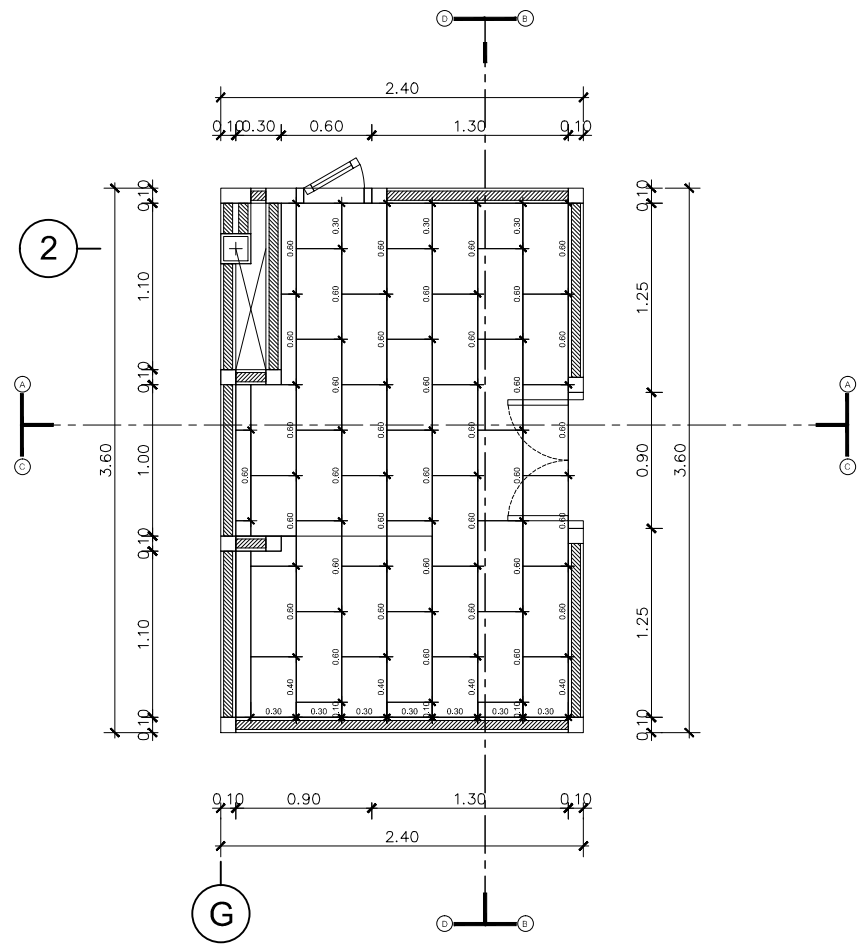

BATHROOM 4 ± FLOOR 2  
SCALE 1:50

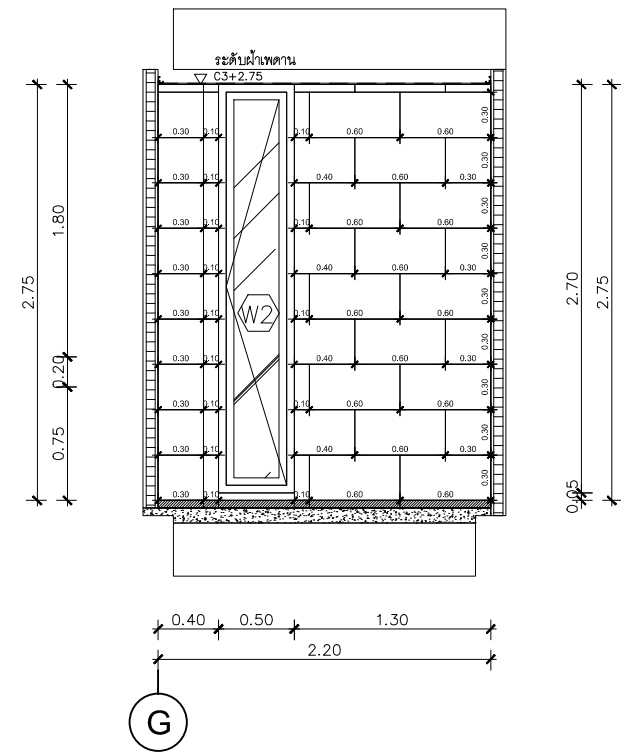

SECTION A  
SCALE 1:50

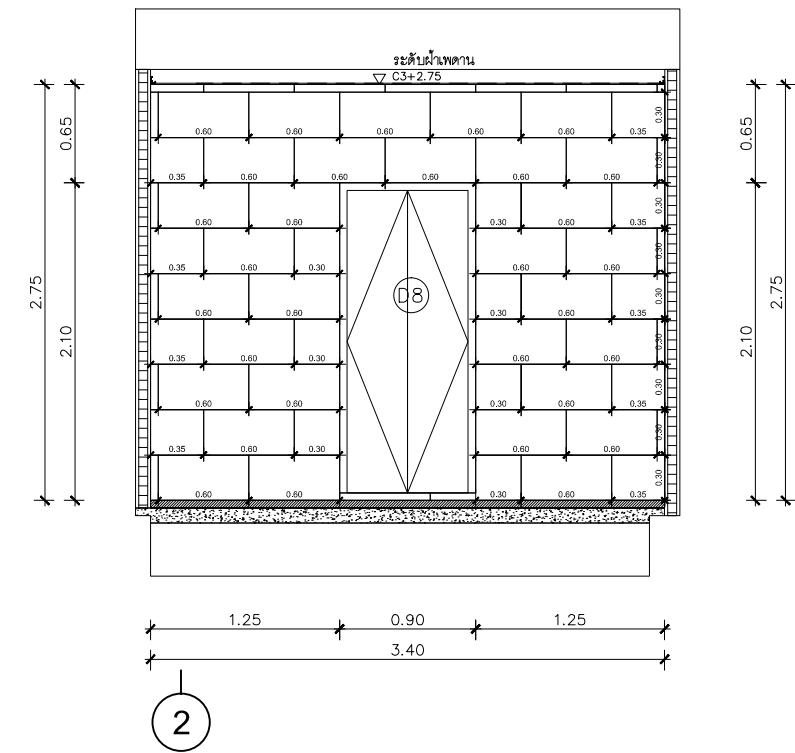

SECTION B  
SCALE 1:50

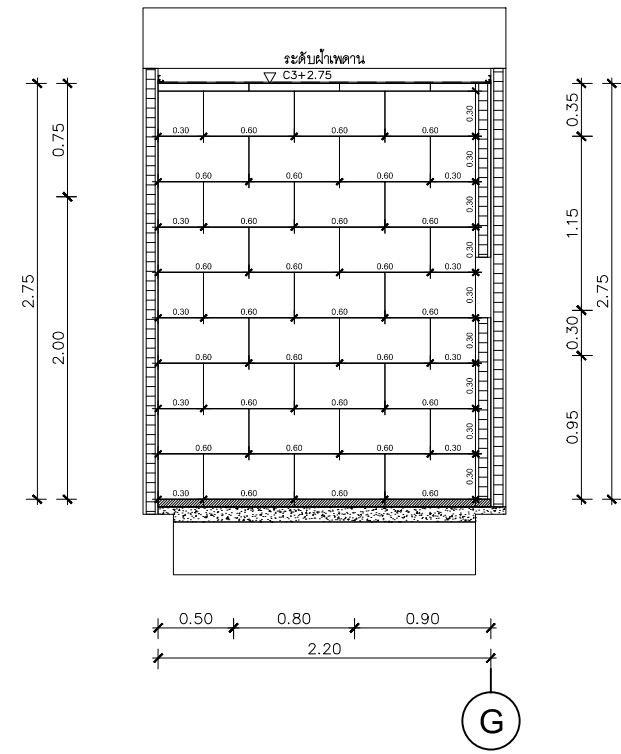

SECTION C  
SCALE 1:50

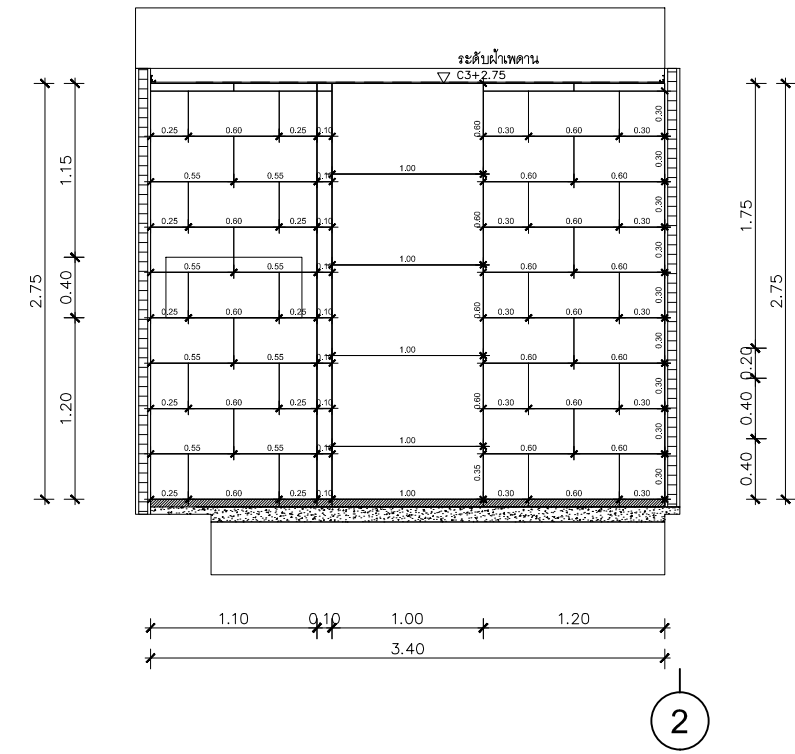

SECTION D  
SCALE 1:50

**P.WE.**  
[PLAY WITH EVERYTHING]  
DESIGN HOUSE

PROJECT NAME:  
**- house**

OWNER:

PROJECT DIRECTOR

**P.WE.**  
[PLAY WITH EVERYTHING]  
DESIGN HOUSE

ARCHITECTS

เชมจิรา ณ นคร  
ภ-สถ 16584

INTERIOR DESIGNER

STRUCTURAL ENGINEERS

นฤตย์พงษ์ เรืองวัฒนานนท์  
ภย.55929  
ELECTRICAL ENGINEERS

SANITARY ENGINEERS

PROJECT MANAGER

REVISION

REV.	DATE	REVISION RECORD
01	26/06/2016	

DRAWING TITLE:

**TOILET DETAIL-1**

CHECKED BY:

DRAWN BY:  
เชมจิรา ณ นคร ภ-สถ 16584

SCALE: 1:50 DATE: 10/08/2016

DRAWING NO. A-10 TOTAL

-This drawing shall not be used for construction unless signed "approved".

PROJECT NAME:  
**- house**

OWNER:

PROJECT DIRECTOR

**P.WE.**  
[PLAY WITH EVERYTHING]  
DESIGN HOUSE

ARCHITECTS

เชมจิรา ณ นคร  
ภ-สถ 16584

INTERIOR DESIGNER

STRUCTURAL ENGINEERS

นฤตย์พงษ์ เรืองวัฒนานนท์  
ภย.55929  
ELECTRICAL ENGINEERS

SANITARY ENGINEERS

PROJECT MANAGER

REVISION

REV.	DATE	REVISION RECORD
01	26/06/2016	

DRAWING TITLE:

**TOILET DETAIL-1**

CHECKED BY:

DRAWN BY:  
เชมจิรา ณ นคร ภ-สถ 16584

SCALE: **1:50** DATE: 10/08/2016

DRAWING NO. **A-10** TOTAL

-This drawing shall not be used for construction unless signed "approved".

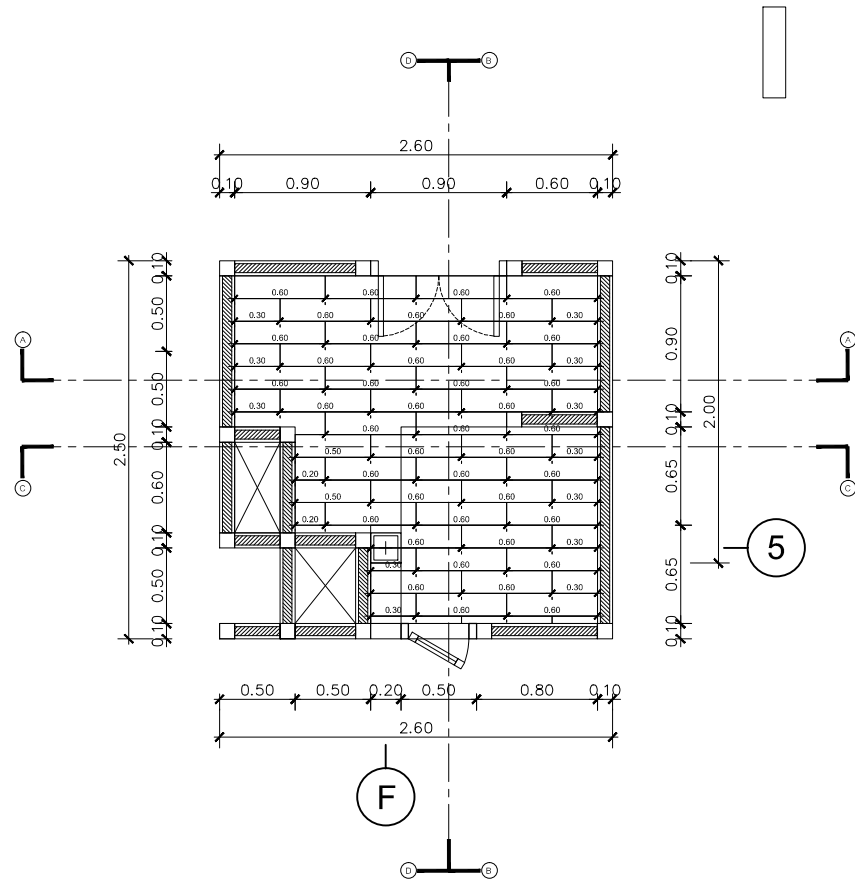

**BATHROOM 5 ± FLOOR 2**  
SCALE 1:50

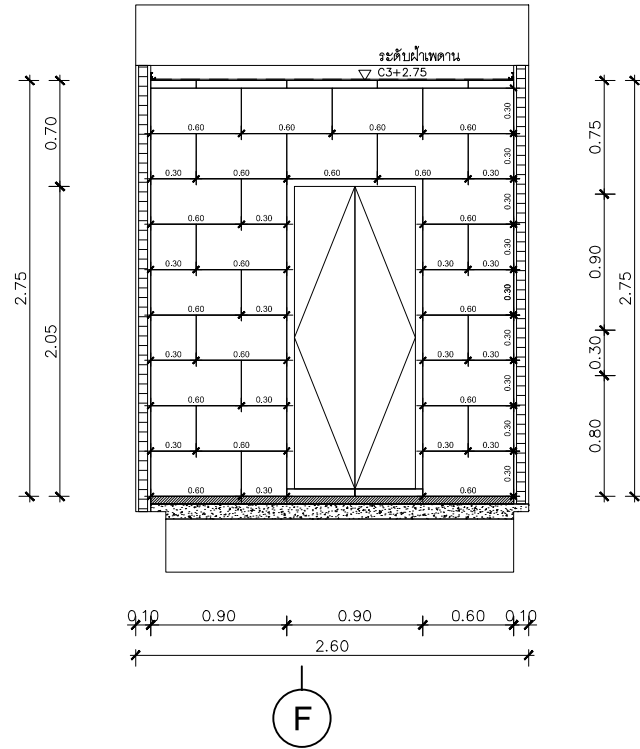
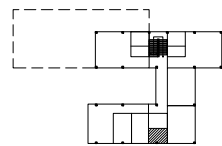

**SECTION A**  
SCALE 1:50

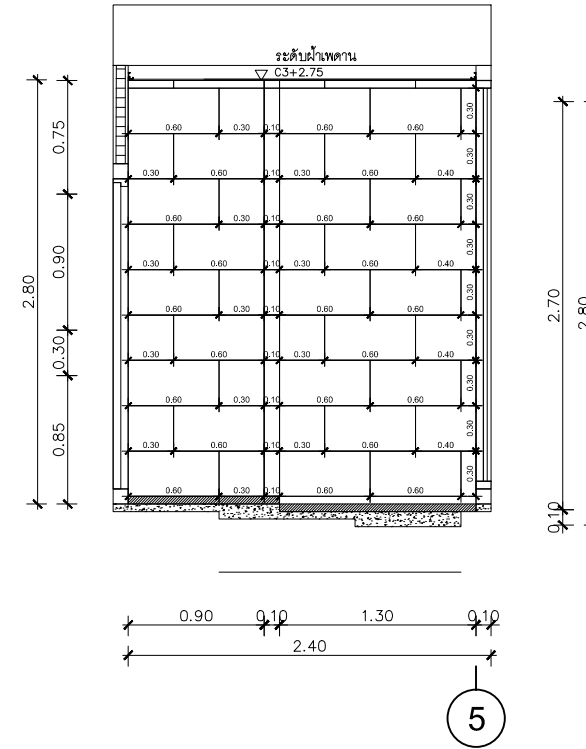

**SECTION B**  
SCALE 1:50

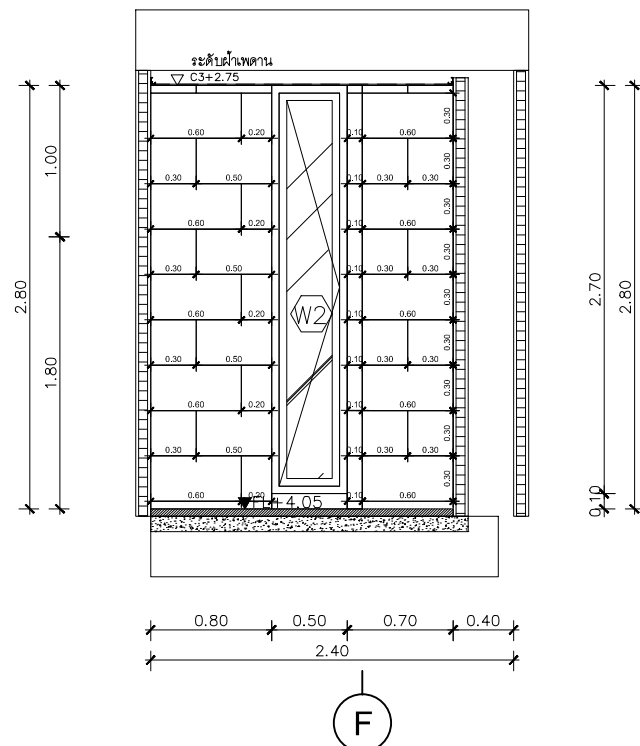

**SECTION C**  
SCALE 1:50

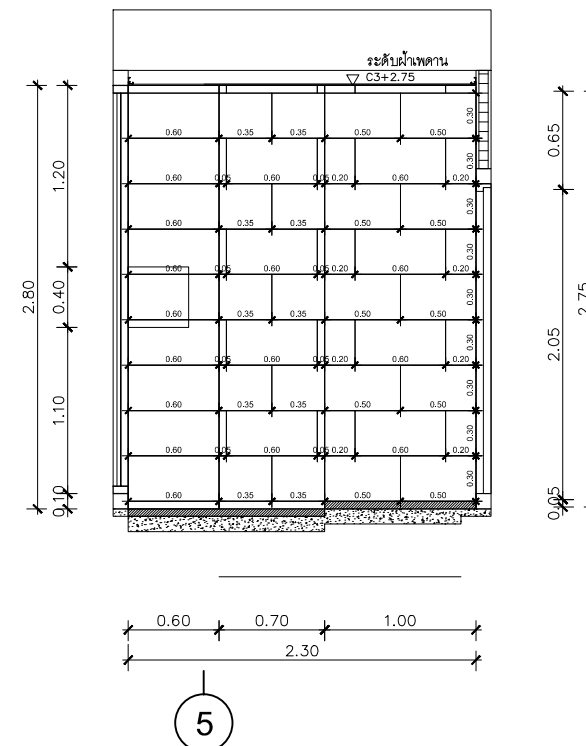

**SECTION D**  
SCALE 1:50



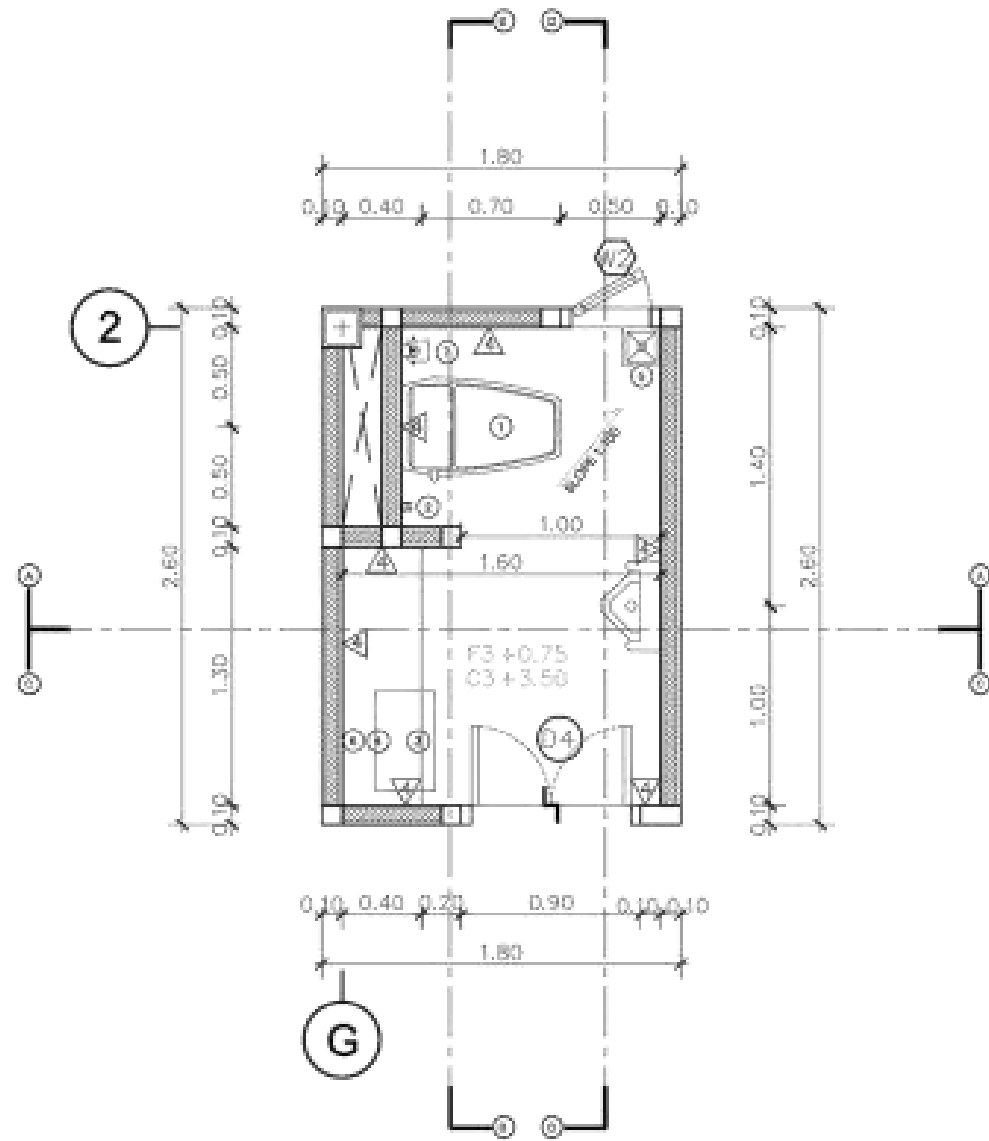

**BATHROOM 1 ± FLOOR 1**

SCALE 1:50



**1** TOILET  
 BRAND : COTTO C124137  
 SIZE : 370 x 710 x 765 mm.



**2** RINSING SPRAY  
 BRAND : COTTO CT982BR#CR(HM)  
 SIZE : -



**7** TISSUE HOLDER  
 BRAND : COTTO CT0025(HM)  
 SIZE : -



**4** FAUCET (WALL)  
 BRAND : COTTO CT1132A  
 SIZE : -



**3** WASH BASIN  
 BRAND : COTTO C02460  
 SIZE : 550 x 168 x 460 mm.



**6** URINAL  
 BRAND : TOTO UFS800CW  
 SIZE : 390 x 420 x 1125 mm.



**5** FLOOR DRAIN  
 BRAND : COTTO CT649H(HM)  
 SIZE : -

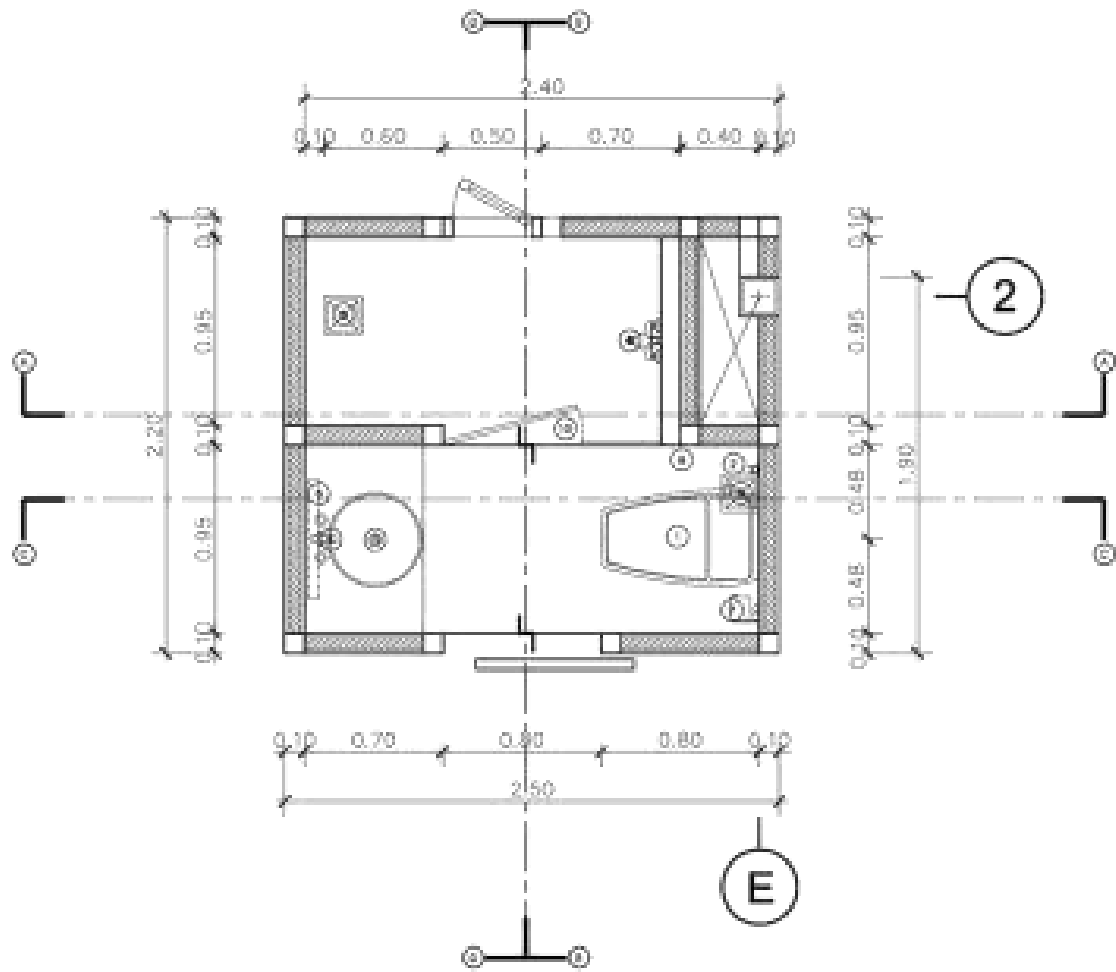

**BATHROOM 3 ± FLOOR 2**

SCALE 1: 50

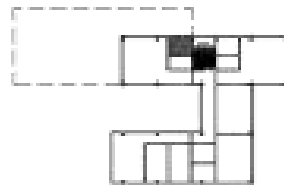

**1** TOILET  
 BRAND : COTTO C124137  
 SIZE : 370 x 710 x 765 mm.



**2** RINSING SPRAY  
 BRAND : WATSON WS-0490 PB  
 SIZE : -



**7** TISSUE HOLDER  
 BRAND : COTTO CT0065#BL(HM)  
 SIZE : -



**4** FAUCET  
 BRAND : COTTO CT2124AY#BL



**3** WASH BASIN  
 BRAND : KASSA  
 SIZE : 46 x 46 x 16 cm.



**8** TOWEL BAR  
 BRAND : COTTO CT0063#BL(HM)  
 SIZE : 65 cm.



**8** SHOWER  
 BRAND : HAFALÉ  
 SIZE : 20 x 106 x 45 cm.



**5** FLOOR DRAIN  
 BRAND : COTTO CT649H(HM)  
 SIZE : -

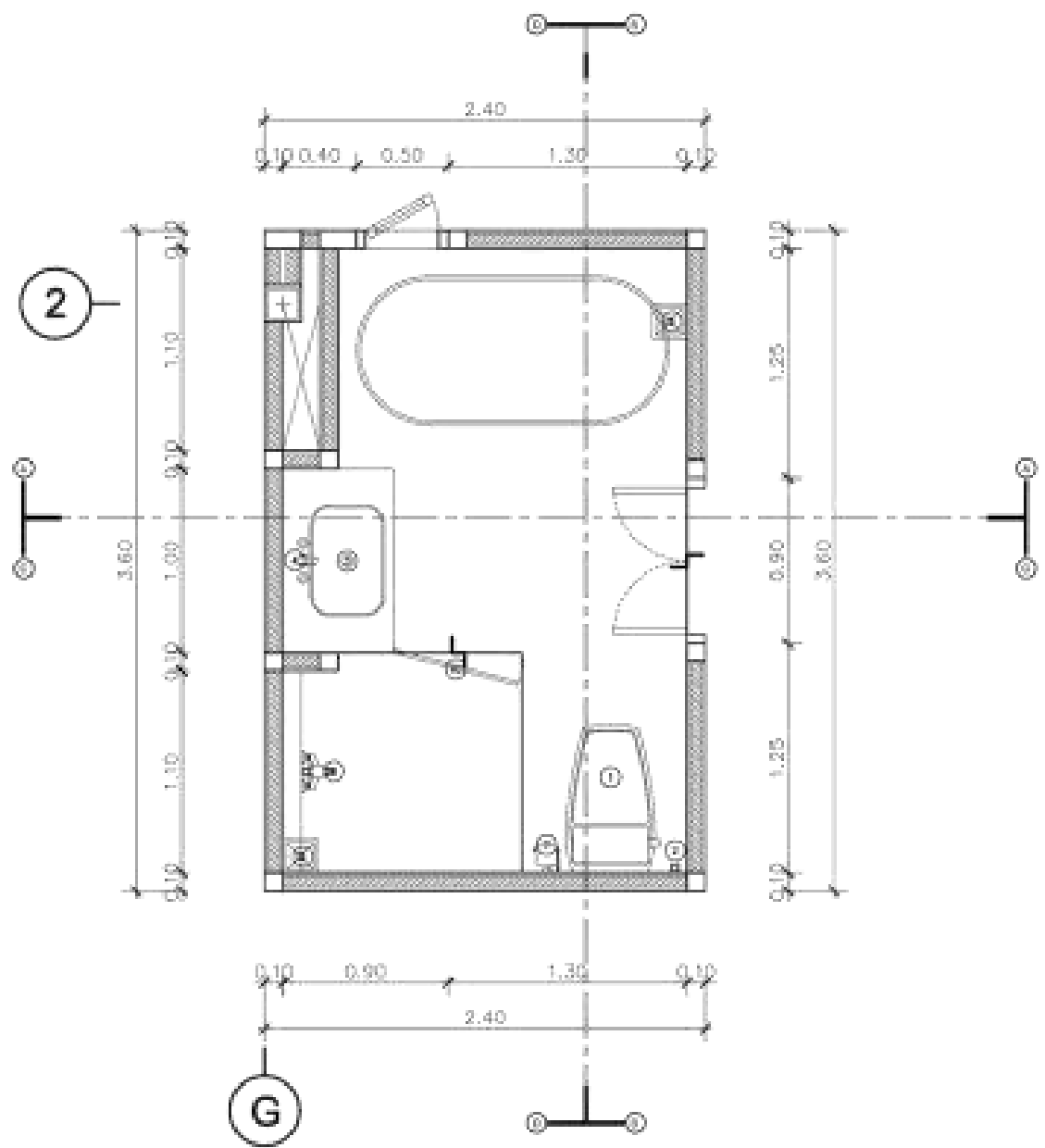

**BATHROOM 4 ± FLOOR 2**

SCALE 1:50

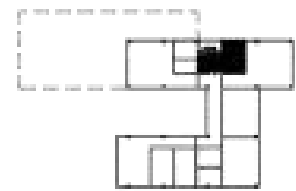

**1** TOILET  
 BRAND : COTTO C124137  
 SIZE : 370 x 710 x 765 mm.



**2** RINSING SPRAY  
 BRAND : COTTO CT982BR#CR(HM)  
 SIZE : -



**7** TISSUE HOLDER  
 BRAND : COTTO CT0025(HM)  
 SIZE : -



**4** FAUCET (WALL)  
 BRAND : COTTO CT2038  
 SIZE : -



**3** WASH BASIN  
 BRAND : KASSA  
 SIZE : -



**-** TOWEL BAR  
 BRAND : COTTO CT0023(HM)  
 SIZE : 76 cm.



**8** SHOWER  
 BRAND : COTTO CT2134W  
 SIZE : -



**11** BATHTUB  
 BRAND : KASSA  
 SIZE : -



**-** FREESTANDING BATHMIXER  
 BRAND : COTTO CT338AXS45  
 SIZE : -



**5** FLOOR DRAIN  
 BRAND : COTTO CT649H(HM)  
 SIZE : -



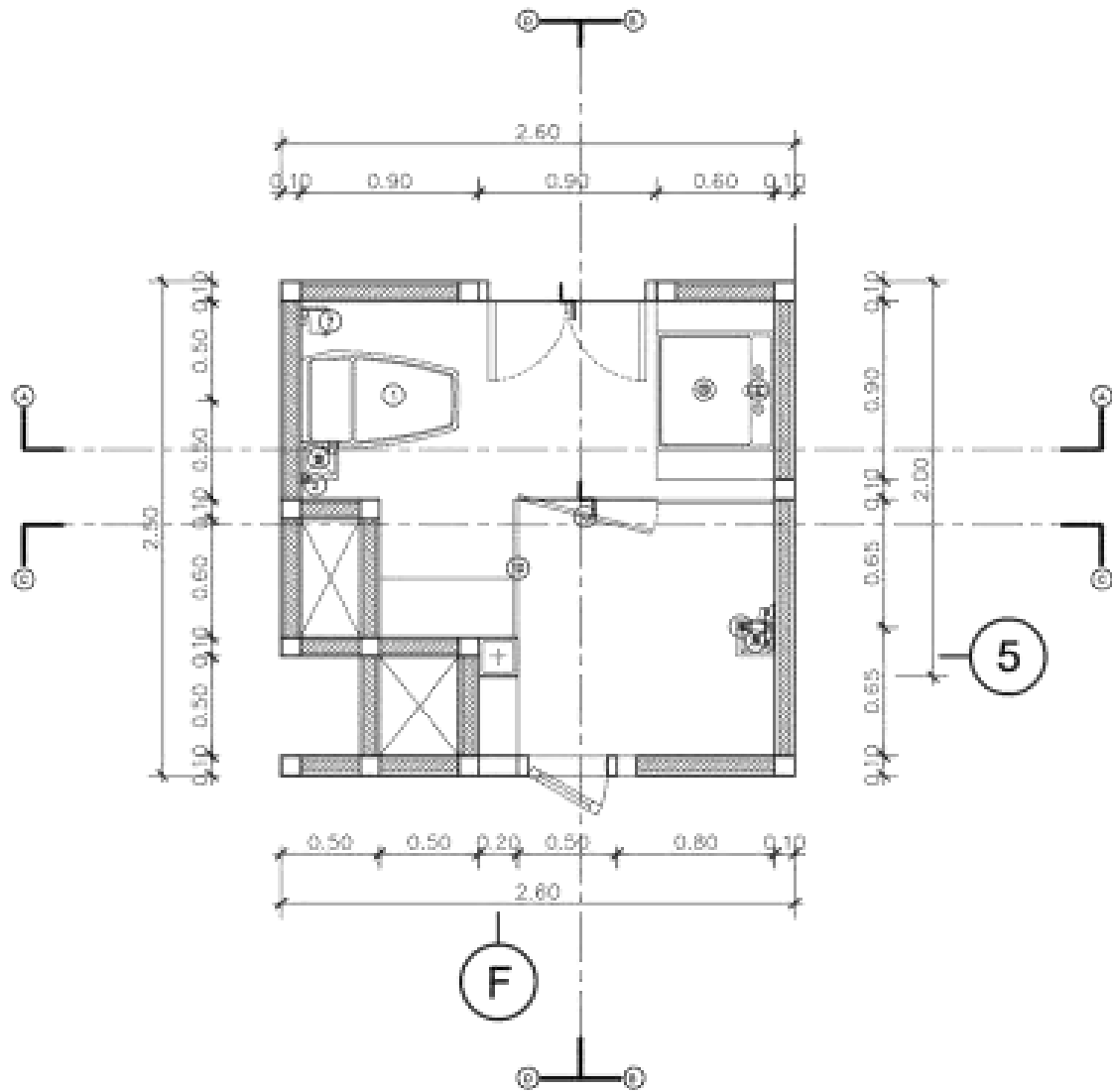

BATHROOM 5 ± FLOOR 2

SCALE 1:50



1 TOILET  
 BRAND : COTTO C124137  
 SIZE : 370 x 710 x 765 mm.



2 RINSING SPRAY  
 BRAND : COTTO CT982BR#CR(HM)  
 SIZE : -



7 TISSUE HOLDER  
 BRAND : COTTO CT0025(HM)  
 SIZE : -



4 FAUCET (WALL)  
 BRAND : COTTO CT2038  
 SIZE : -



3 WASH BASIN  
 BRAND : KASSA LT-107  
 SIZE : 70 x 40 x 12.5 cm.



TOWEL BAR  
 BRAND : COTTO CT0222(HM)  
 SIZE : 60 cm.



8 SHOWER  
 BRAND : COTTO CT2134W  
 SIZE : -



5 FLOOR DRAIN  
 BRAND : COTTO CT649H(HM)  
 SIZE : -

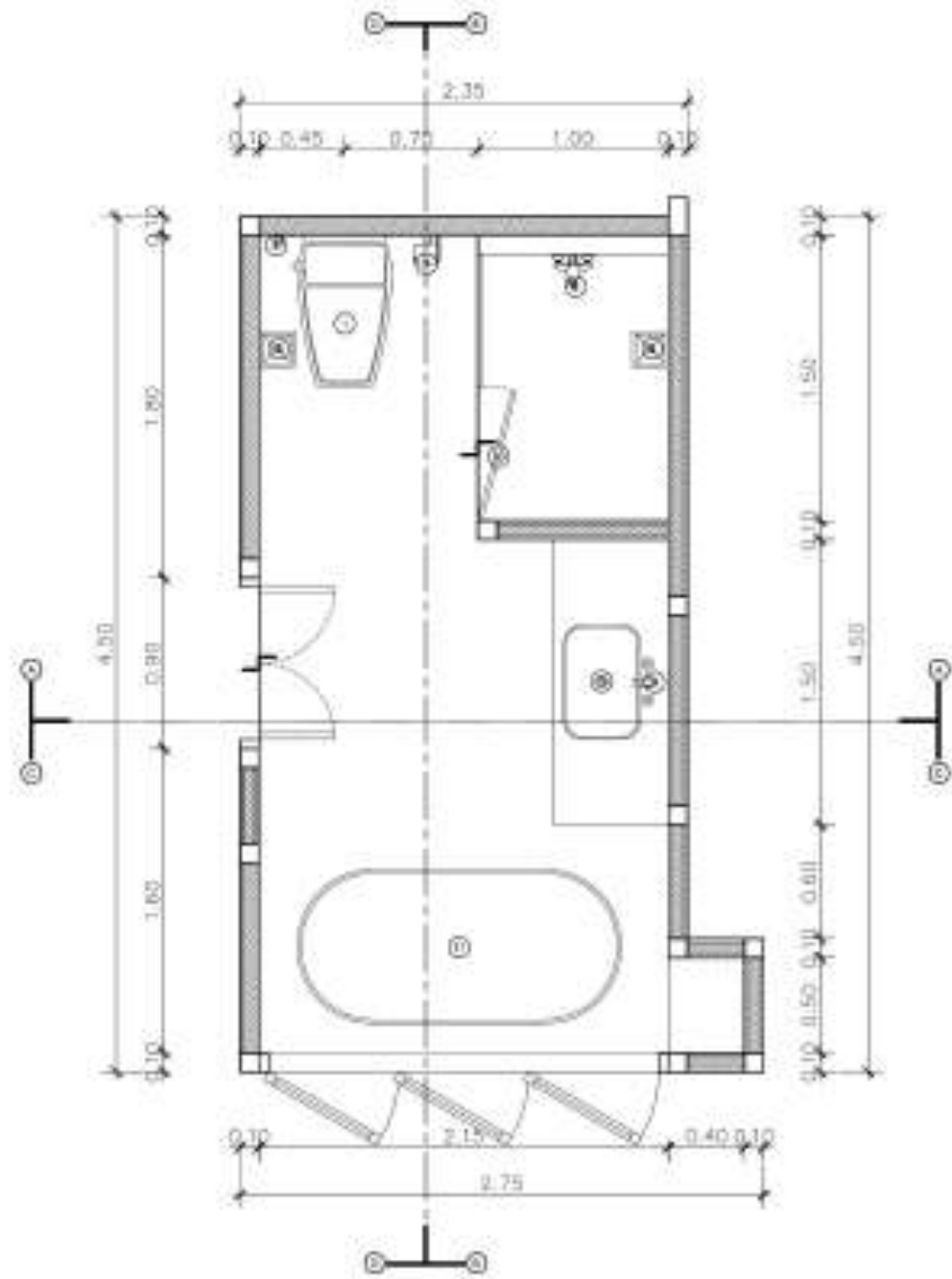

BATHROOM 6 (CHEE) ± FLOOR 2  
SCALE 1:50

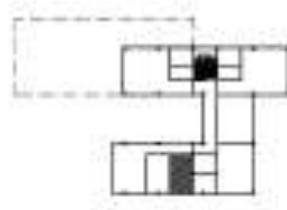

1 TOILET  
BRAND : COTTO C124137  
SIZE : 370 x 710 x 765 mm.



2 RINSING SPRAY  
BRAND : COTTO CT982BR#CR(HM)  
SIZE : -



7 TISSUE HOLDER  
BRAND : COTTO CT0025(HM)  
SIZE : -



4 FAUCET (WALL)  
BRAND : COTTO CT2038  
SIZE : -



3 WASH BASIN  
BRAND : KASSA LT-107  
SIZE : 70 x 40 x 12.5 cm.



- TOWEL BAR  
BRAND : COTTO CT0023(HM)  
SIZE : 76 cm.



8 SHOWER  
BRAND : COTTO CT2134W  
SIZE : -



11 BATHTUB  
BRAND : KASSA  
SIZE : -



- FREESTANDING BATHMIXER  
BRAND : COTTO CT338AXS45  
SIZE : -



5 FLOOR DRAIN  
BRAND : COTTO CT649H(HM)  
SIZE : -

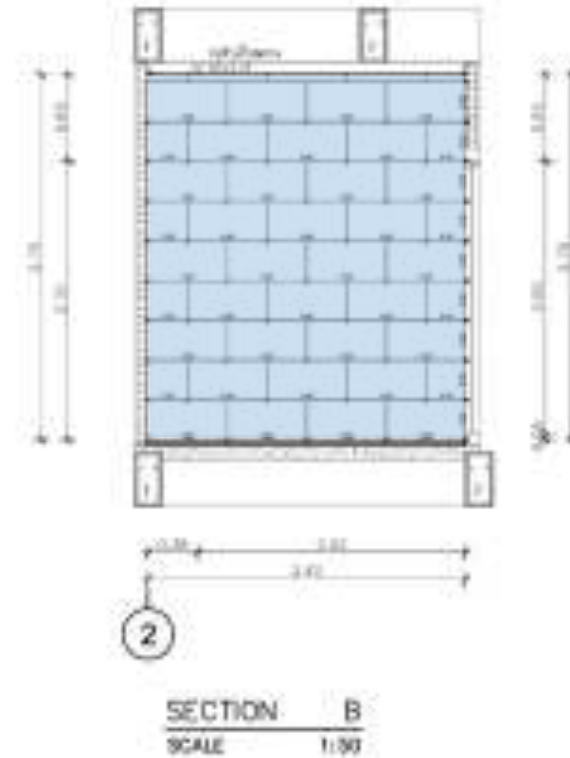
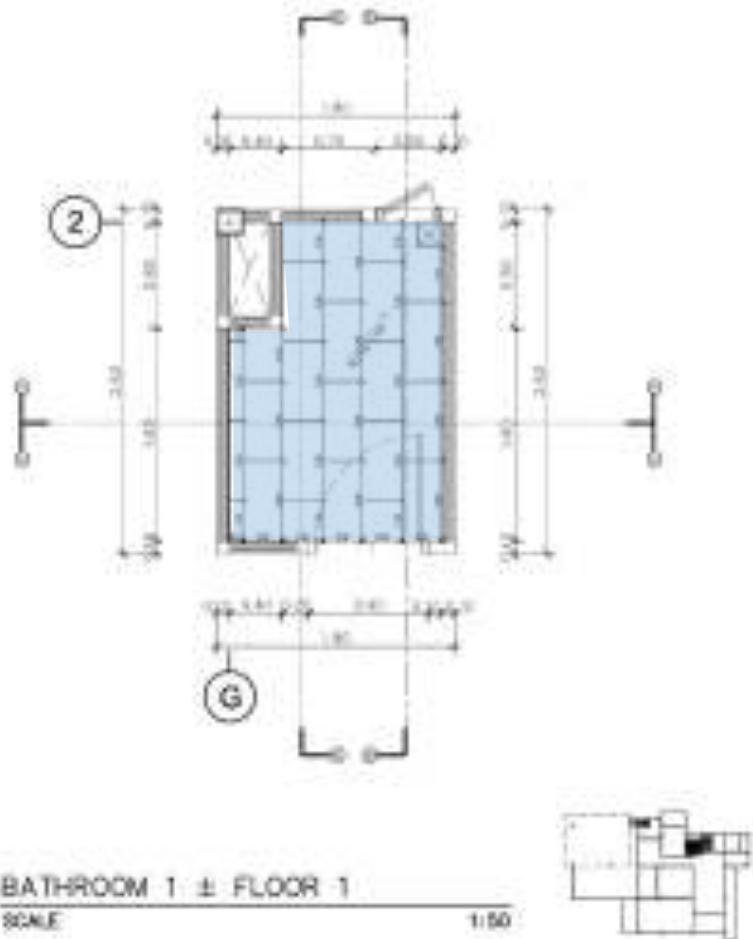

**P.WE.**  
PUNJAN ENGINEERING  
DESIGNHOUSE

PROJECT NAME:  
**house**

ARCHITECT:  
PROJECT DIRECTOR:

**P.WE.**  
PUNJAN ENGINEERING  
DESIGNHOUSE

ARCHITECT:  
PROJECT DIRECTOR:

STRUCTURAL ENGINEER:  
ELECTRICAL ENGINEER:

SANITARY ENGINEER:

PROJECT MANAGER:

REV.	DATE	REVISION REASON
01	28/08/2024	

DRAWING FILE:

**TOILET DETAIL-1**

CHECKED BY:

DRAWN BY:  
DATE: 1:50  
SCALE: 1:50

DRAWING NO.: **A-10**

-This drawing shall not be used for construction unless signed "approved".



**DBLIZZARD PERLA REC.(GT632400R)**  
SIZE : 60 x 30 cm.  
รหัสสินค้า : 1058050

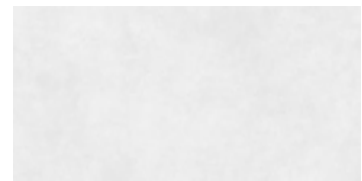

**HORIZON WHITE (SR5059A)**  
SIZE : 60 x 30 cm.  
รหัสสินค้า : 1076308

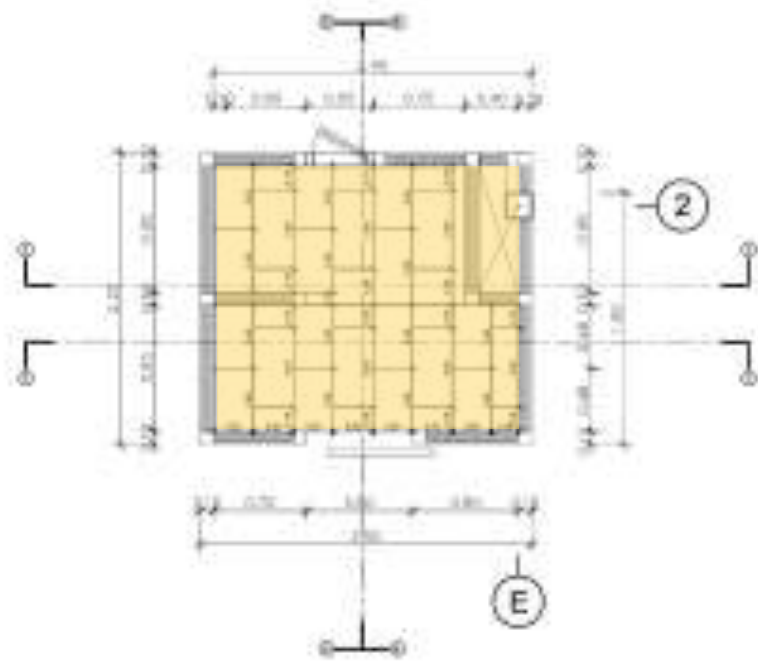

BATHROOM 3 ± FLOOR 2

SCALE 1:50

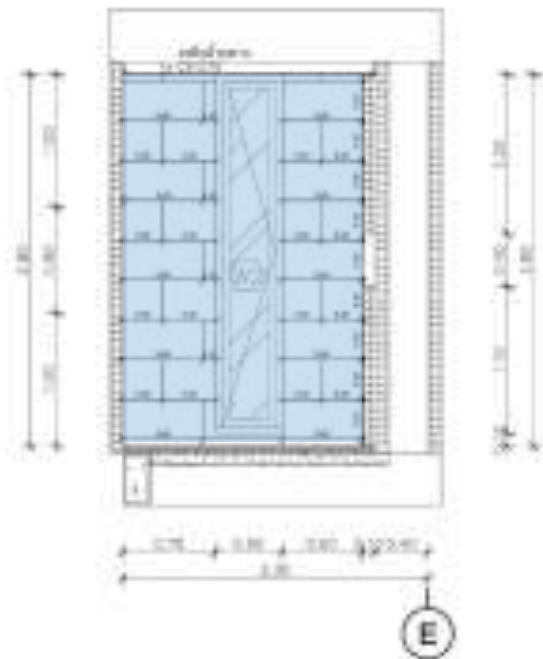
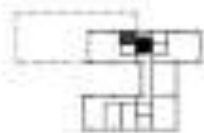

SECTION A  
SCALE 1:50

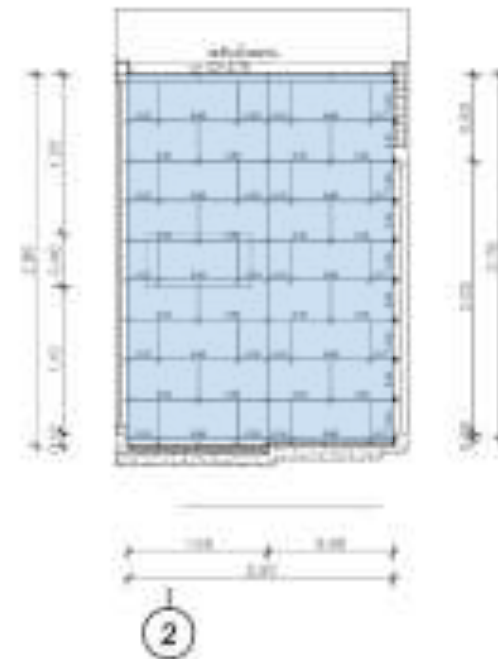

SECTION B  
SCALE 1:50

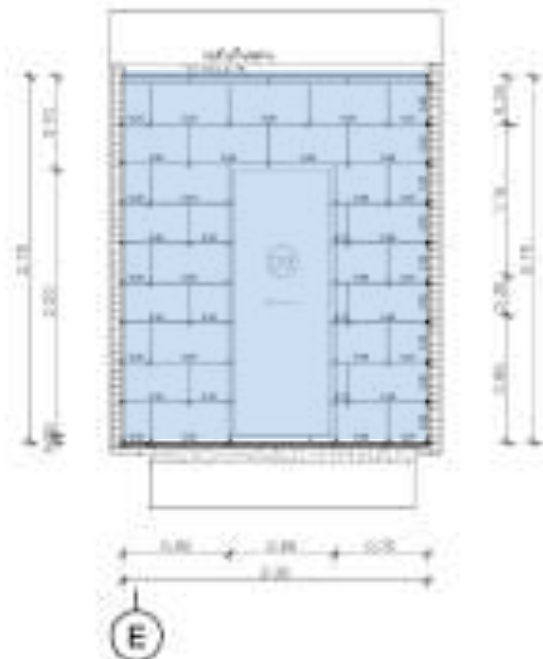

SECTION C  
SCALE 1:50

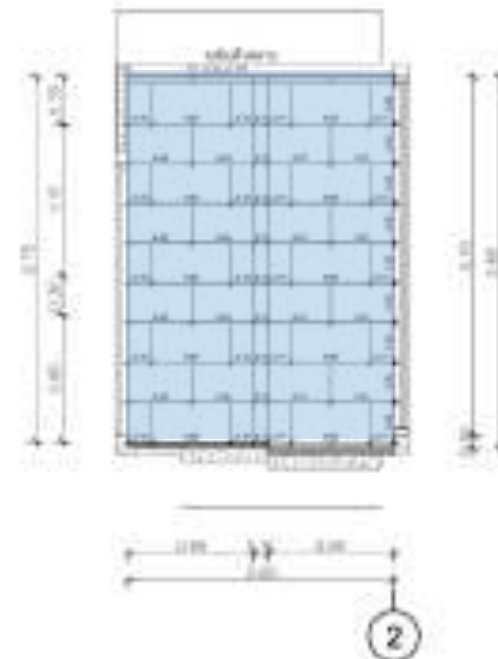

SECTION D  
SCALE 1:50

**P.WE.**  
PLANNING ENGINEERING  
DESIGNHOUSE

PROJECT NAME:

house

ARCHITECT:

PROJECT DIRECTOR:

**P.WE.**

PLANNING ENGINEERING  
DESIGNHOUSE

ARCHITECT:

PROJECT NO. 101  
2-80 10001

ARCHITECT:

STRUCTURAL ENGINEER:

นายพิเชษฐ์ ใจดี  
09-058204

ELECTRICAL ENGINEER:

SANITARY ENGINEER:

PROJECT MANAGER:

REVISION:

REV.	DATE	REVISION REASON
01	28/06/2018	

DRAWING FILE:

TOILET DETAIL-1

CHECKED BY:

DRAWN BY:

นายพิเชษฐ์ ใจดี 2-80 10001  
SCALE 1:50 DATE 10/06/2018

DRAWING NO. A-10 TOTAL

"This drawing shall not be used for construction unless signed 'approved'."



เค้ม-สโตน กราไฟท์(ตัดขอบ)(PK8)R10

SIZE : 60 x 30 cm.

รหัสสินค้า : 1080133\*\*



เค้ม-สโตน เทา (ตัดขอบ) (PK8) R10

SIZE : 60 x 30 cm.

รหัสสินค้า : 1080134\*\*

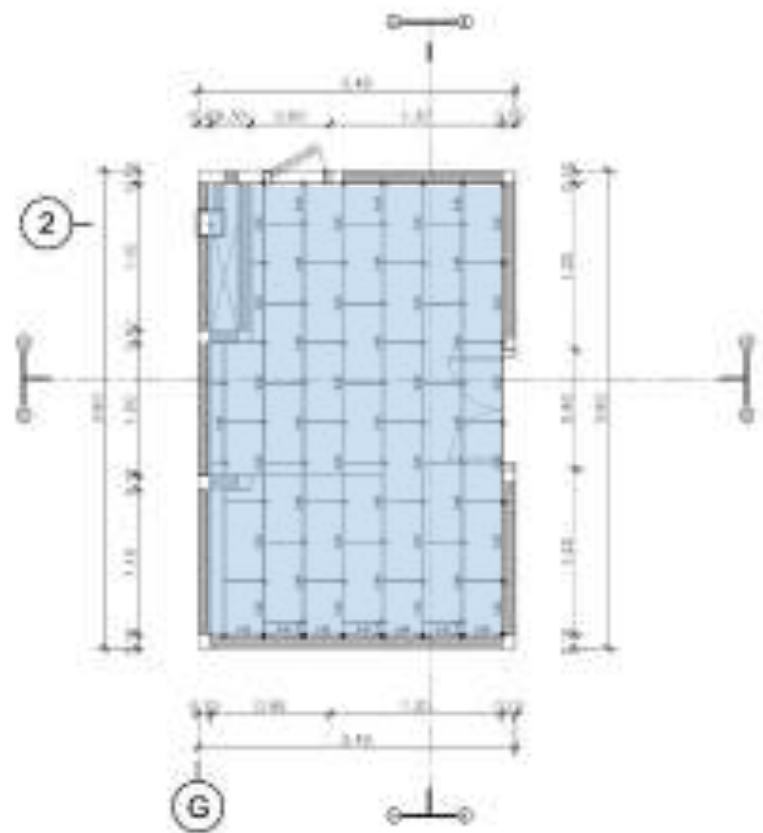

BATHROOM 4 ± FLOOR 2  
SCALE 1:50

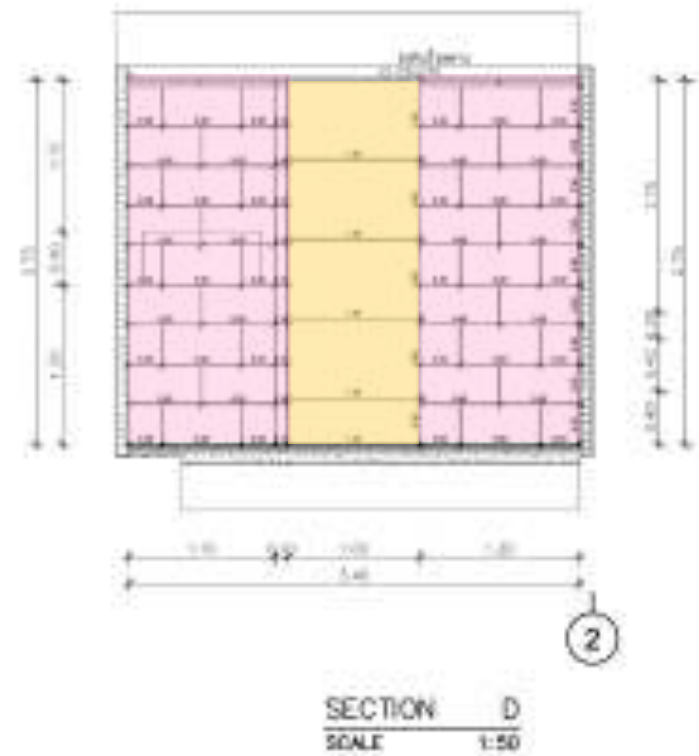
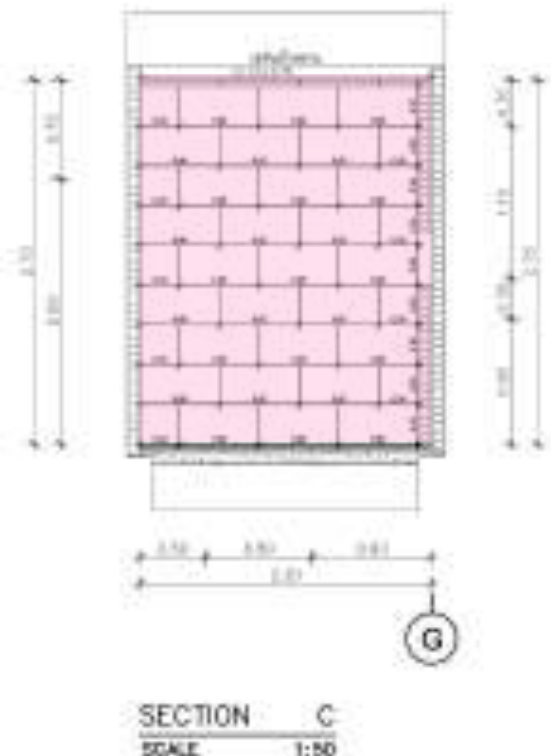
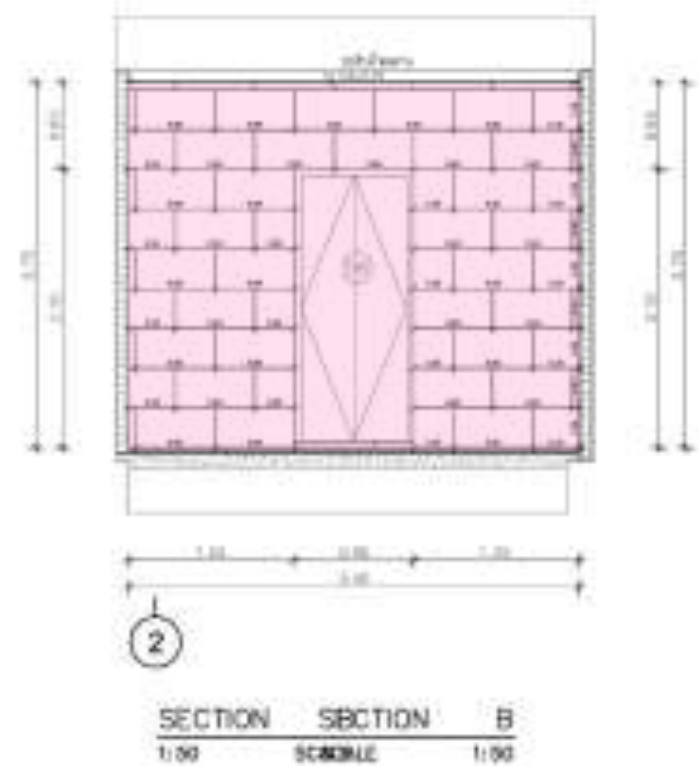
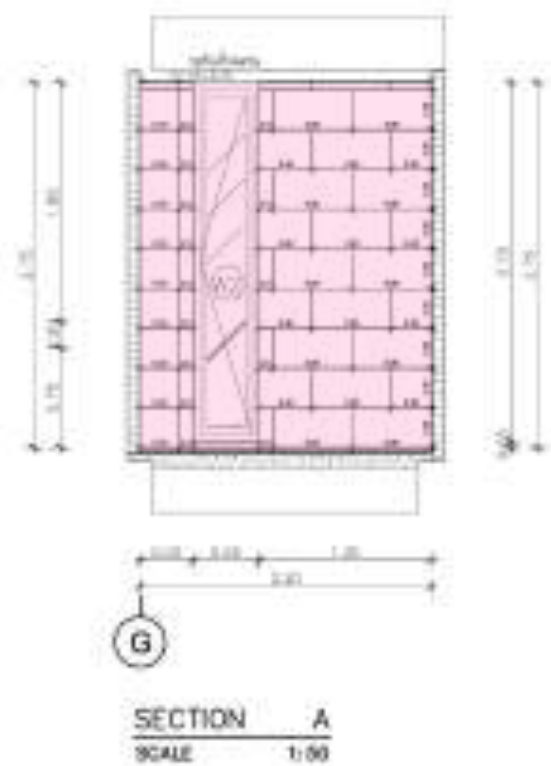
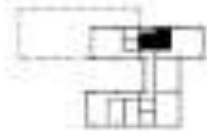

P.WE.  
PLANNING ENGINEERING  
DESIGNHOUSE

PROJECT NAME:  
house

PROJECT DIRECTOR:  
P.WE.  
PLANNING ENGINEERING  
DESIGNHOUSE

ARCHITECTS:  
วิศวกร ภูมิสถาปัตย์  
2-80 10001

STRUCTURAL ENGINEER:  
วิศวกร วิศวกรรมโยธา  
20.5/204

ELECTRICAL ENGINEER:

SANITARY ENGINEER:

PROJECT MANAGER:

REV.	DATE	REVISION REASON
01	28/08/2018	

DRAWING FILE:  
TOILET DETAIL-1

CHECKED BY:  
DRAWN BY:  
วิศวกร ภูมิสถาปัตย์ 2-80 10001  
SCALE: 1:50 DATE: 10/08/2018  
DRAWING NO.: A-10

-This drawing shall not be used for construction unless signed "approved".



PRUS WH.(QP8321MB1260)  
SIZE : 60 x 120 cm.  
รหัสสินค้า : 1086804



ไฮโดรเวียร์ สโนว์ (ตัดขอบ) (PK8)  
SIZE : 60 x 30 cm.  
รหัสสินค้า : 1083624\*\*



คาราเมล ขาว (PK8)  
SIZE : 60 x 30 cm.  
รหัสสินค้า : 1101142

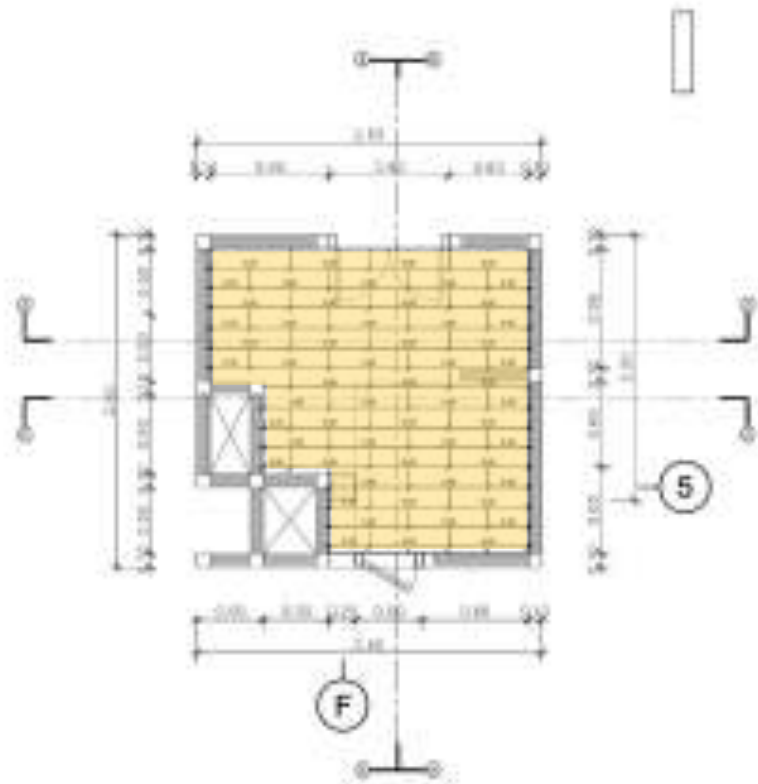

BATHROOM 5 ± FLOOR 2  
SCALE 1:50

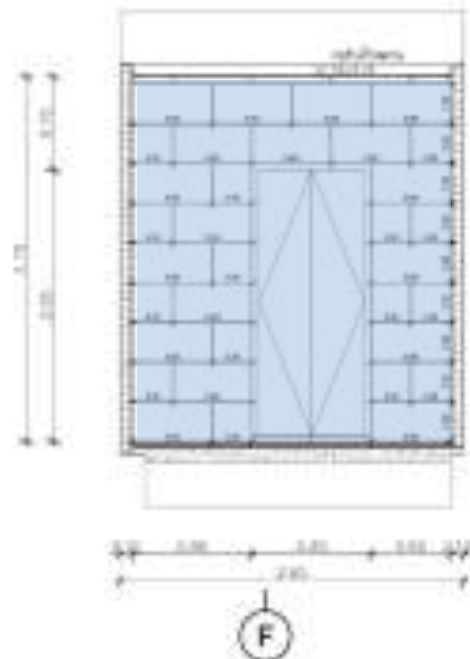

SECTION A  
SCALE 1:50

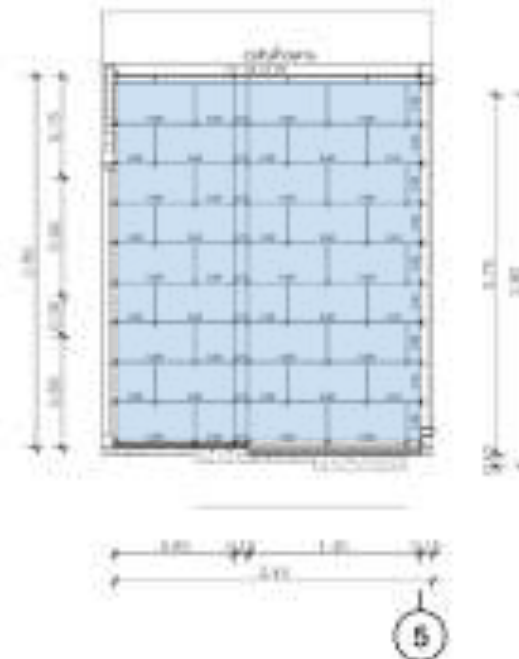

SECTION B  
SCALE 1:50

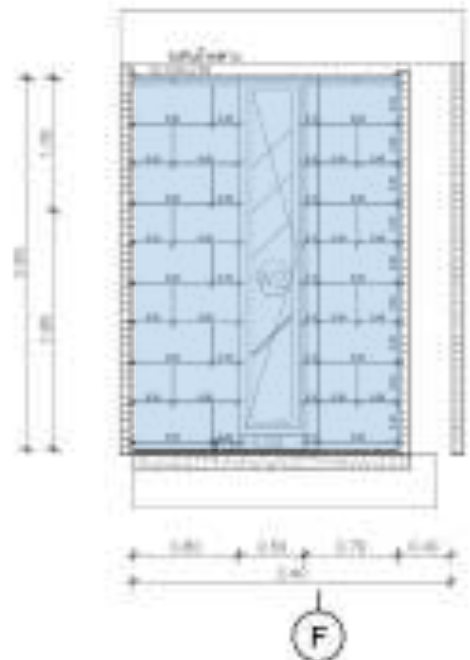

SECTION C  
SCALE 1:50

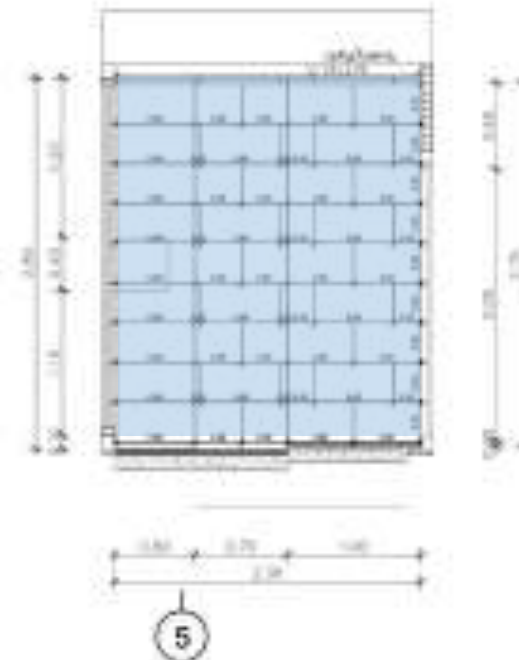

SECTION D  
SCALE 1:50

P.WE.  
PLANNING ENGINEERING  
DESIGNHOUSE

PROJECT NAME:

house

ARCHITECT:

PROJECT DIRECTOR:

P.WE.

PLANNING ENGINEERING  
DESIGNHOUSE

ARCHITECT:

PROJECT NO. 101  
DATE: 10/10/2014

REVISION RECORD:

STRUCTURAL ENGINEER:

วิศวกรโครงสร้าง  
P.WE.

ELECTRICAL ENGINEER:

SANITARY ENGINEER:

PROJECT MANAGER:

REVISION:

REV.	DATE	REVISION RECORD
01	28/08/2014	

DRAWING FILE:

TOILET DETAIL-1

CHECKED BY:

DRAWN BY:

วิศวกร 101 P.WE. 10/10/2014  
SCALE: 1:50 DATE: 10/10/2014

DRAWING NO.:

A-10

-This drawing shall not be used for construction unless signed "approved".



WOODLAND BROWN (QDC6154075)

SIZE : 60 x 15 cm.

รหัสสินค้า : 1030407\*\*



DVERCELL FRESH (1W63438R)

SIZE : 60 x 30 cm.

รหัสสินค้า : 1098763