

BEDROOM 4

P.WE.

[PLAY WITH EVERYTHING]
DESIGN HOUSE

PROJECT NAME:

- house

OWNER:

PROJECT DIRECTOR

P.WE.

[PLAY WITH EVERYTHING]
DESIGN HOUSE

ARCHITECTS

เขมจิรา ณ นคร
ภ-สถ 16584

INTERIOR DESIGNER

STRUCTURAL ENGINEERS

นฤตย์พงษ์ เรืองวัฒนานนท์
ภย.55929

ELECTRICAL ENGINEERS

SANITARY ENGINEERS

PROJECT MANAGER

REVISION

REV.	DATE	REVISION RECORD
01	26/06/2016	

DRAWING TITLE:

CHECKED BY:

DRAWN BY:

เขมจิรา ณ นคร ภ-สถ 16584

SCALE: 1 : 20 DATE: 10/08/2016

DRAWING NO. TOTAL

-This drawing shall not be used for construction unless signed "approved".

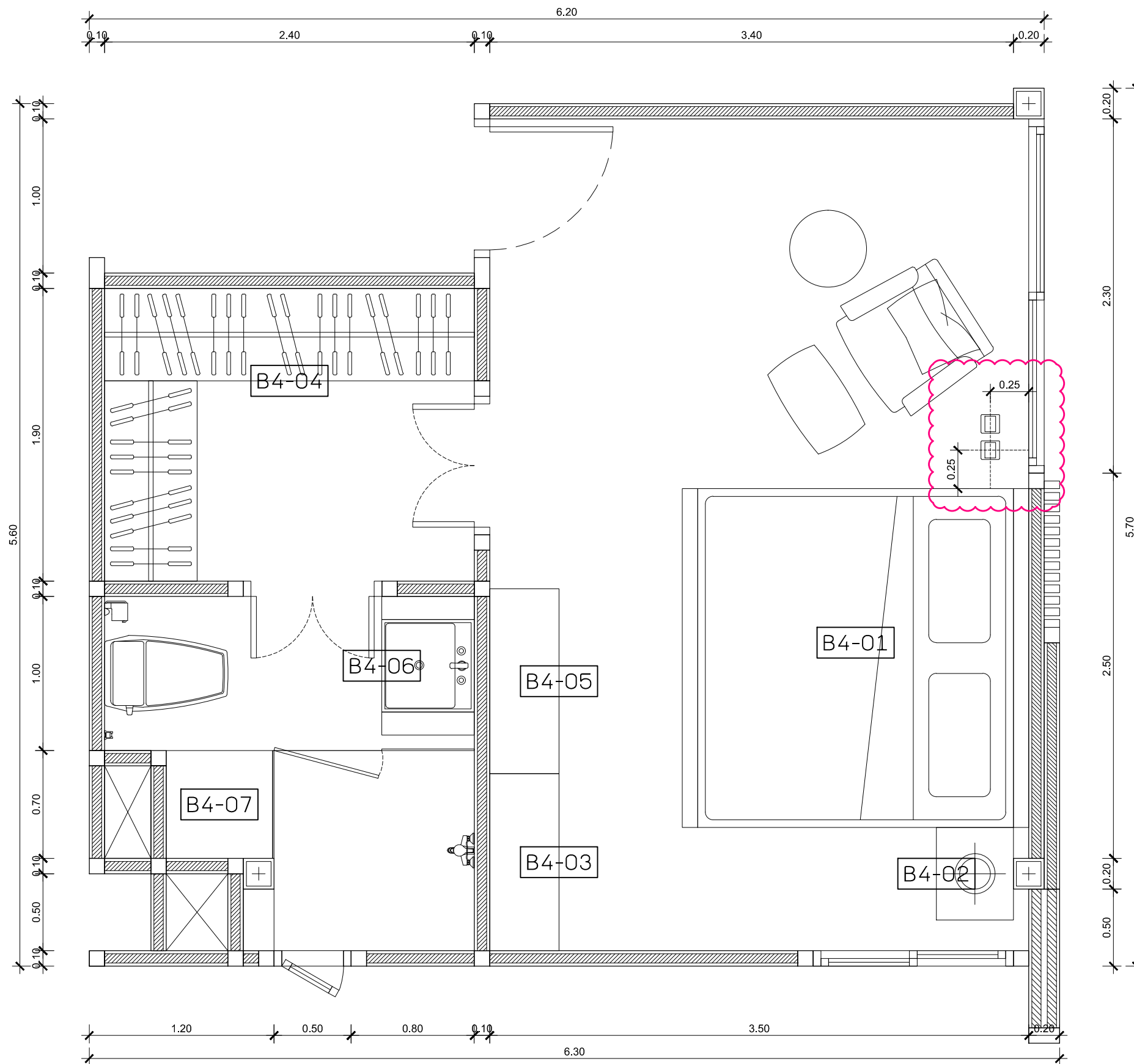

BEDROOM 4 FURNITURE LAYOUT
SCALE 1: 30

P.WE.
[PLAY WITH EVERYTHING]
DESIGN HOUSE

PROJECT NAME:

- house

OWNER:

PROJECT DIRECTOR

P.WE.
[PLAY WITH EVERYTHING]
DESIGN HOUSE

ARCHITECTS

เขมจิรา ณ นคร
ภ-สถ 16584

INTERIOR DESIGNER

STRUCTURAL ENGINEERS

นฤตย์พงษ์ เรืองวัฒนานนท์
ภย.55929

ELECTRICAL ENGINEERS

SANITARY ENGINEERS

PROJECT MANAGER

REVISION

REV.	DATE	REVISION RECORD
01	26/06/2016	

DRAWING TITLE:

CHECKED BY:

DRAWN BY
เขมจิรา ณ นคร ภ-สถ 16584

SCALE: A-07 DATE: 10/08/2016

DRAWING NO. TOTAL

-This drawing shall not be used for construction unless signed "approved".

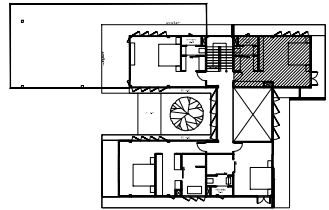
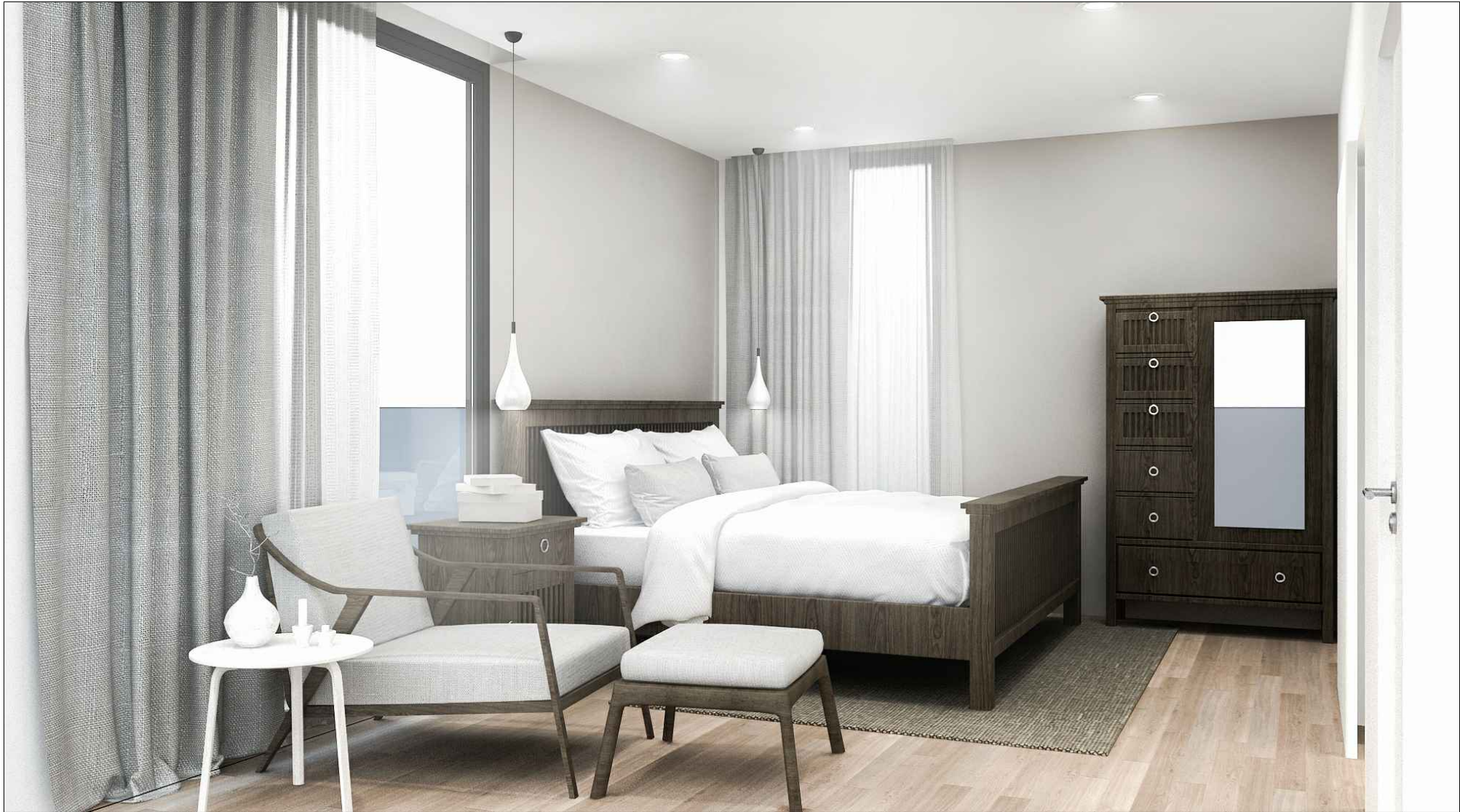

BEDROOM 4 PERSPECTIVE

SCALE 1: 20

P.WE.
[PLAY WITH EVERYTHING]
DESIGN HOUSE

PROJECT NAME:
- house

OWNER:

PROJECT DIRECTOR

P.WE.
[PLAY WITH EVERYTHING]
DESIGN HOUSE

ARCHITECTS

เขมจิรา ณ นคร
ภ-สถ 16584

INTERIOR DESIGNER

STRUCTURAL ENGINEERS

นฤตย์พงษ์ เรืองวัฒนานนท์
ภย.55929

ELECTRICAL ENGINEERS

SANITARY ENGINEERS

PROJECT MANAGER

REVISION

REV.	DATE	REVISION RECORD
01	26/06/2016	

DRAWING TITLE:

CHECKED BY:

DRAWN BY:
เขมจิรา ณ นคร ภ-สถ 16584

SCALE: 1 : 20 DATE: 10/08/2016

DRAWING NO. A-07 TOTAL

-This drawing shall not be used for construction unless signed "approved".

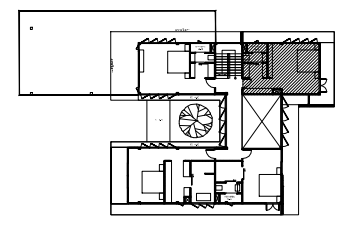

BEDROOM 4 PERSPECTIVE

SCALE 1: 20

P.WE.
[PLAY WITH EVERYTHING]
DESIGN HOUSE

PROJECT NAME:
- house

OWNER:

PROJECT DIRECTOR

P.WE.
[PLAY WITH EVERYTHING]
DESIGN HOUSE

ARCHITECTS

เขมจิรา ณ นคร
ภ-สถ 16584

INTERIOR DESIGNER

STRUCTURAL ENGINEERS

นฤตย์พงษ์ เรืองวัฒนานนท์
ภย.55929

ELECTRICAL ENGINEERS

SANITARY ENGINEERS

PROJECT MANAGER

REVISION

REV.	DATE	REVISION RECORD
01	26/06/2016	

DRAWING TITLE:

CHECKED BY:

DRAWN BY:
เขมจิรา ณ นคร ภ-สถ 16584

SCALE: 1 : 20 DATE: 10/08/2016

DRAWING NO.	TOTAL
A-07	

-This drawing shall not be used for construction unless signed "approved".

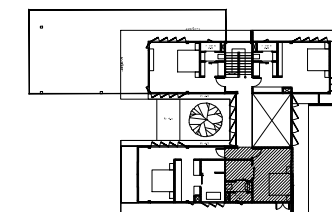

BEDROOM 4 PERSPECTIVE

SCALE

1:20

P.WE.

[PLAY WITH EVERYTHING]
DESIGN HOUSE

PROJECT NAME:

- house

OWNER:

PROJECT DIRECTOR

P.WE.

[PLAY WITH EVERYTHING]
DESIGN HOUSE

ARCHITECTS

เขมจิรา ณ นคร
ภ-สถ 16584

INTERIOR DESIGNER

STRUCTURAL ENGINEERS

นฤตย์พงษ์ เรืองวัฒนานนท์
ภย.55929

ELECTRICAL ENGINEERS

SANITARY ENGINEERS

PROJECT MANAGER

REVISION

REV.	DATE	REVISION RECORD
01	26/06/2016	

DRAWING TITLE:

CHECKED BY:

DRAWN BY:

เขมจิรา ณ นคร ภ-สถ 16584

SCALE:
1 : 20

DATE:
10/08/2016

DRAWING NO.

A-07

TOTAL

-This drawing shall not be used for construction unless signed "approved".

PROJECT NAME:

- house

OWNER:

PROJECT DIRECTOR

ARCHITECTS

เขมจิรา ณ นคร
ภ-สถ 16584

INTERIOR DESIGNER

STRUCTURAL ENGINEERS

นฤตย์พงษ์ เรืองวัฒนานนท์
ภย.55929
ELECTRICAL ENGINEERS

SANITARY ENGINEERS

PROJECT MANAGER

REVISION

REV.	DATE	REVISION RECORD
01	26/06/2016	

DRAWING TITLE:

CHECKED BY:

DRAWN BY:
เขมจิรา ณ นคร ภ-สถ 16584

SCALE: 1 : 20 DATE: 10/08/2016

DRAWING NO. A-07 TOTAL

-This drawing shall not be used for construction unless signed "approved".

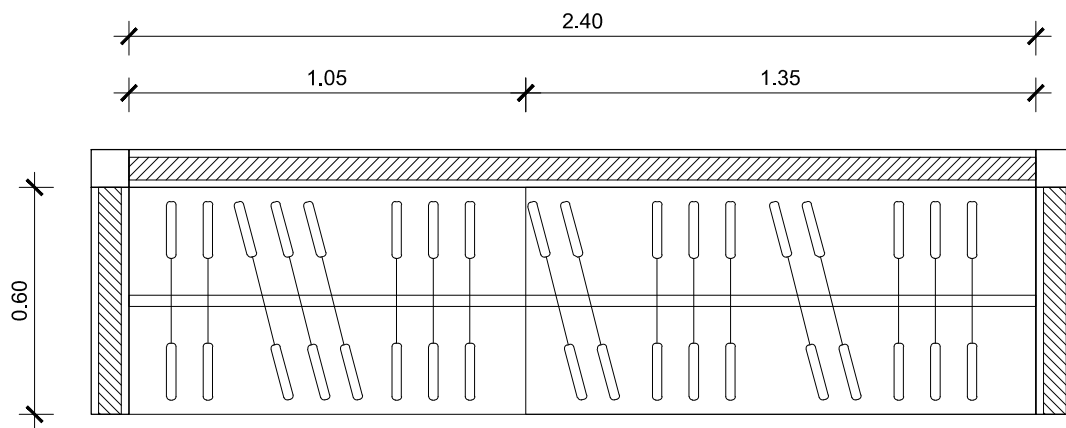

B4-04 PLAN
SCALE 1: 20

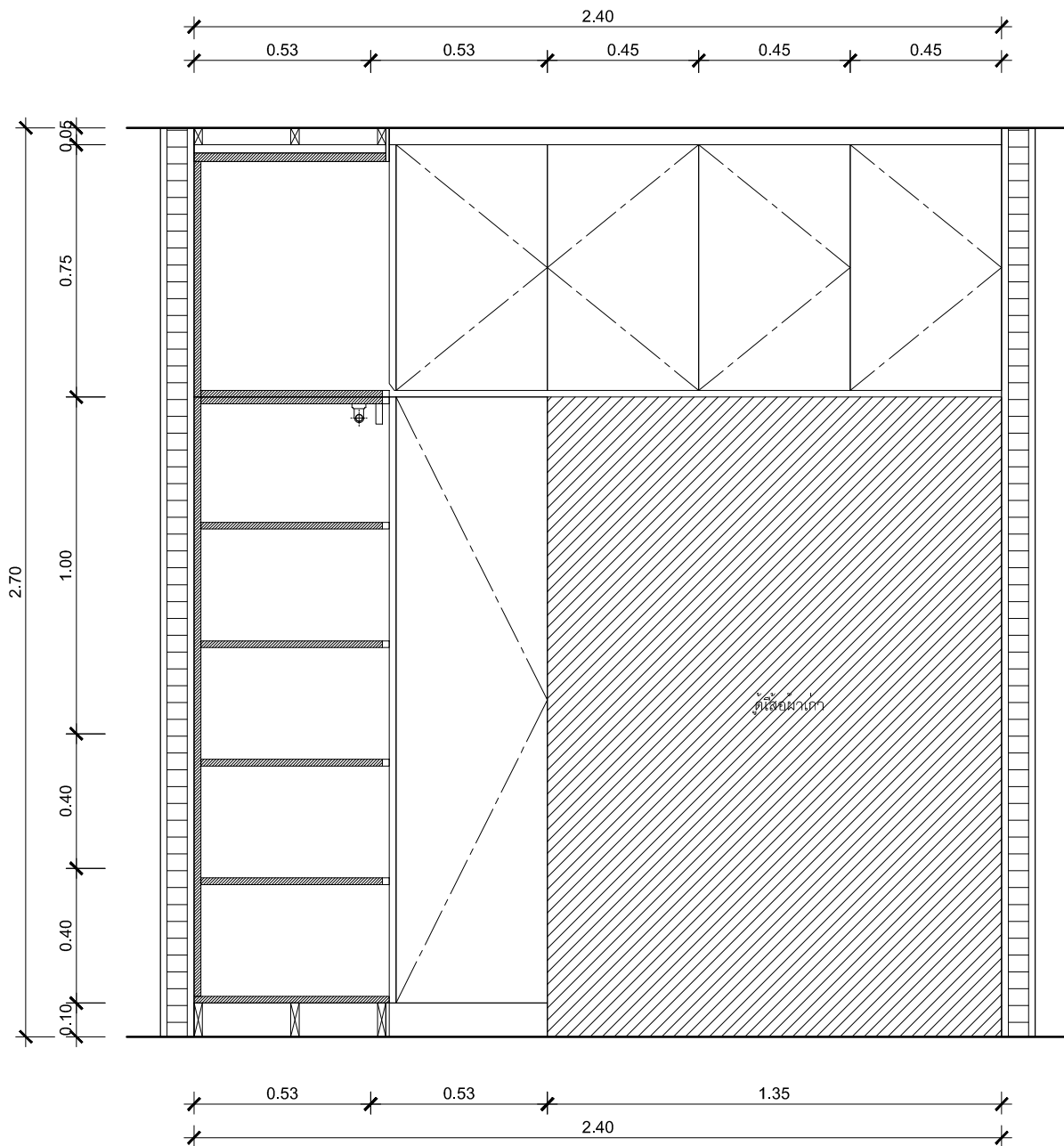

B4-04 ELEVATION
SCALE 1: 20

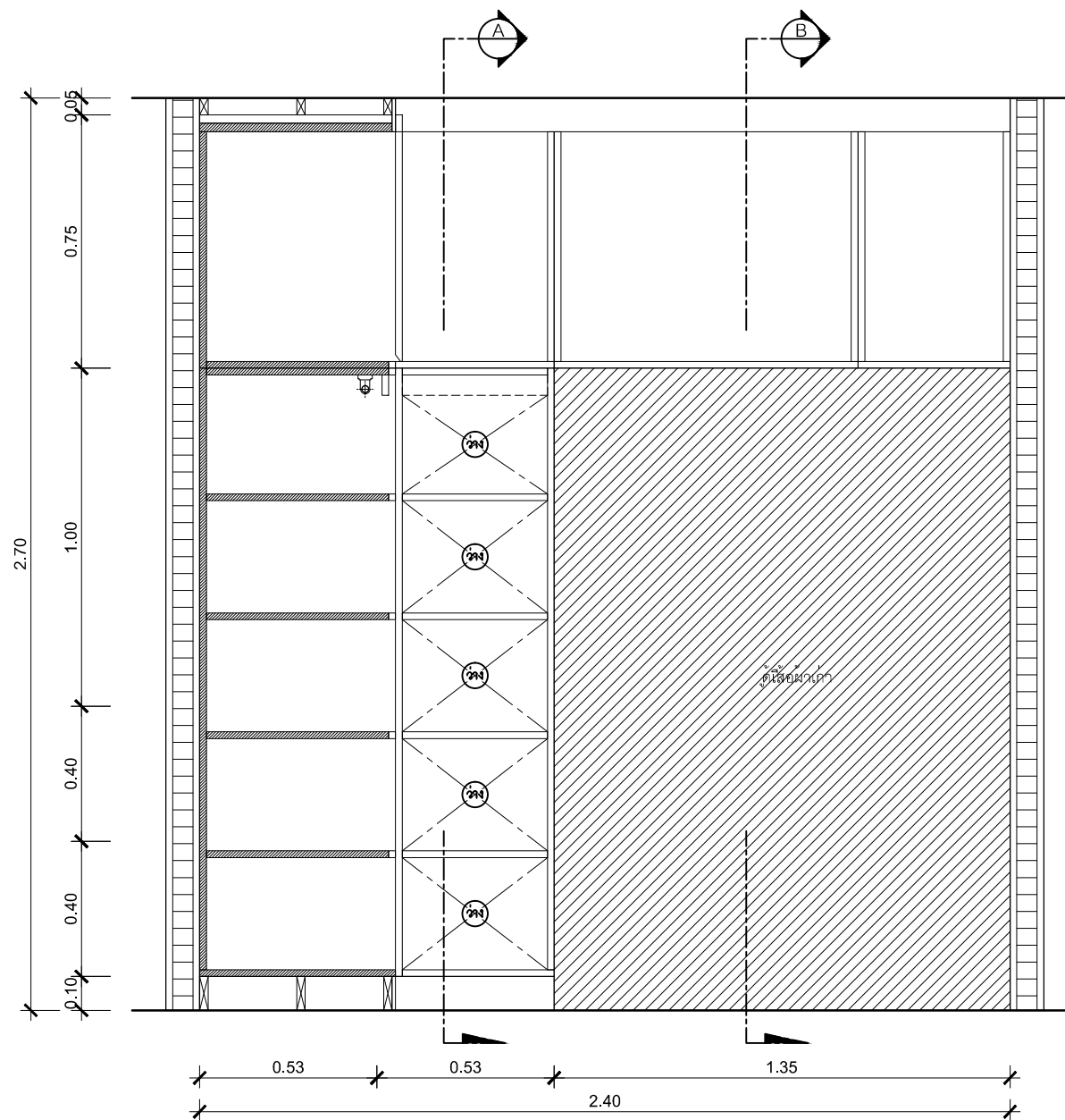

B4-04 ELEVATION (INSIDE)
SCALE 1: 20

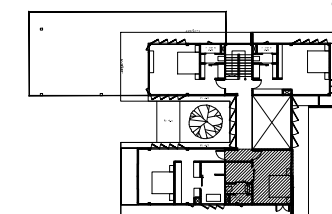

BEDROOM 4 B4-04
SCALE 1: 20

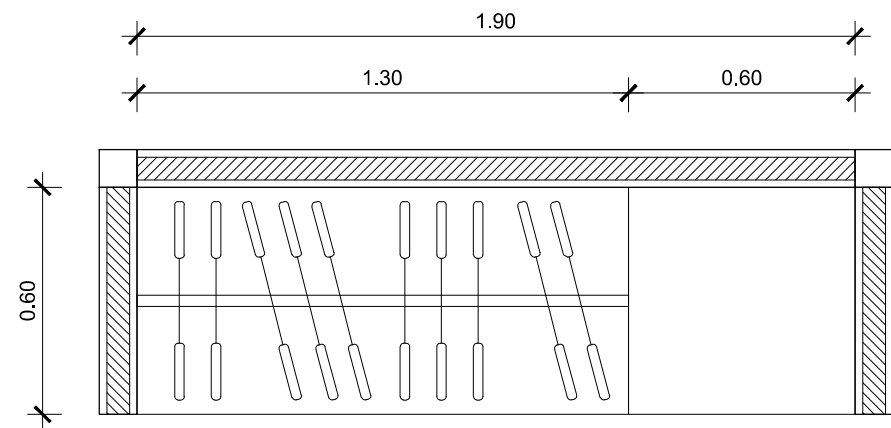

B4-04 PLAN
SCALE 1:20

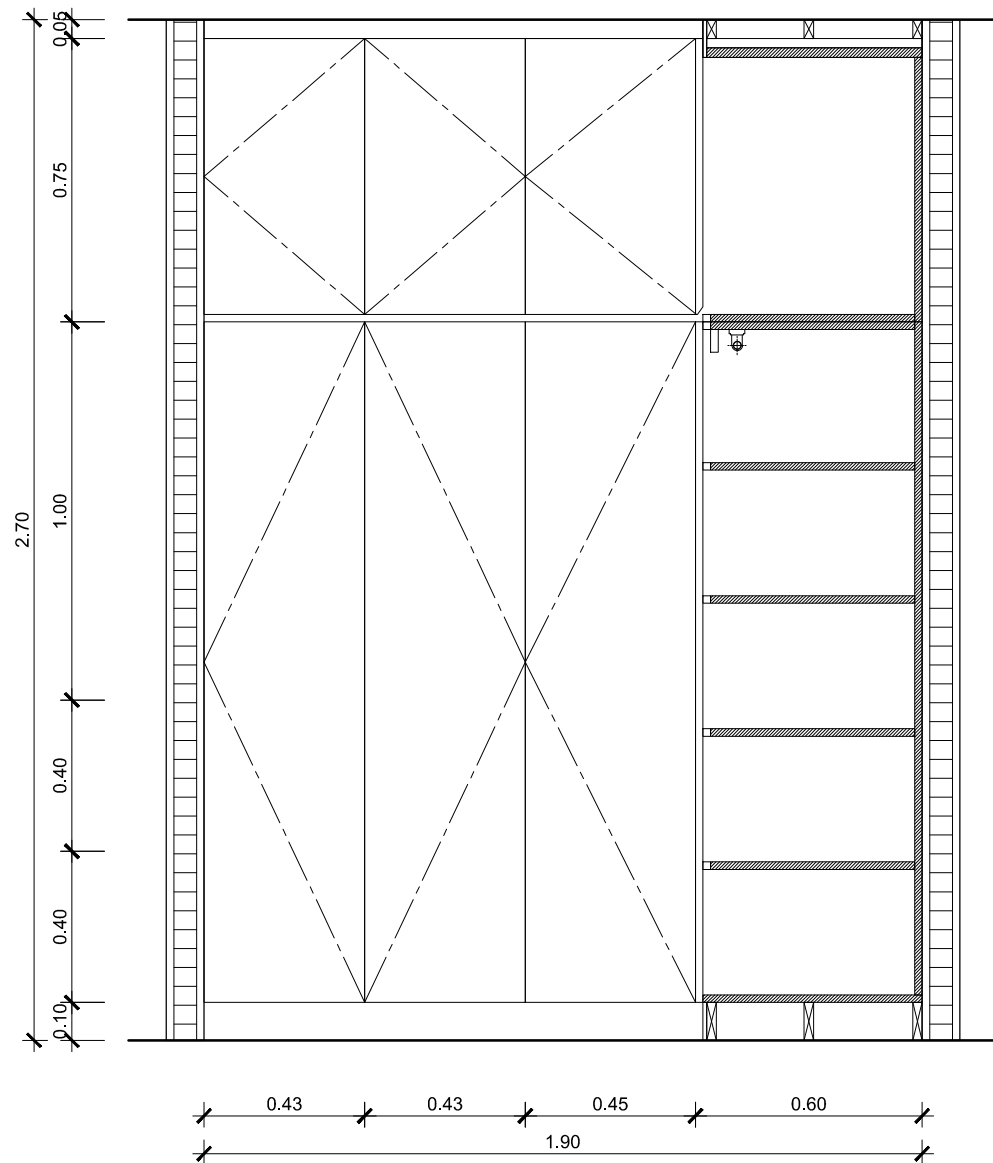
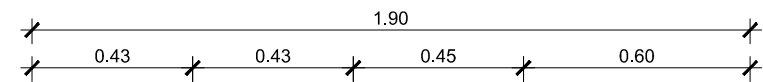

B4-04 ELEVATION
SCALE 1:20

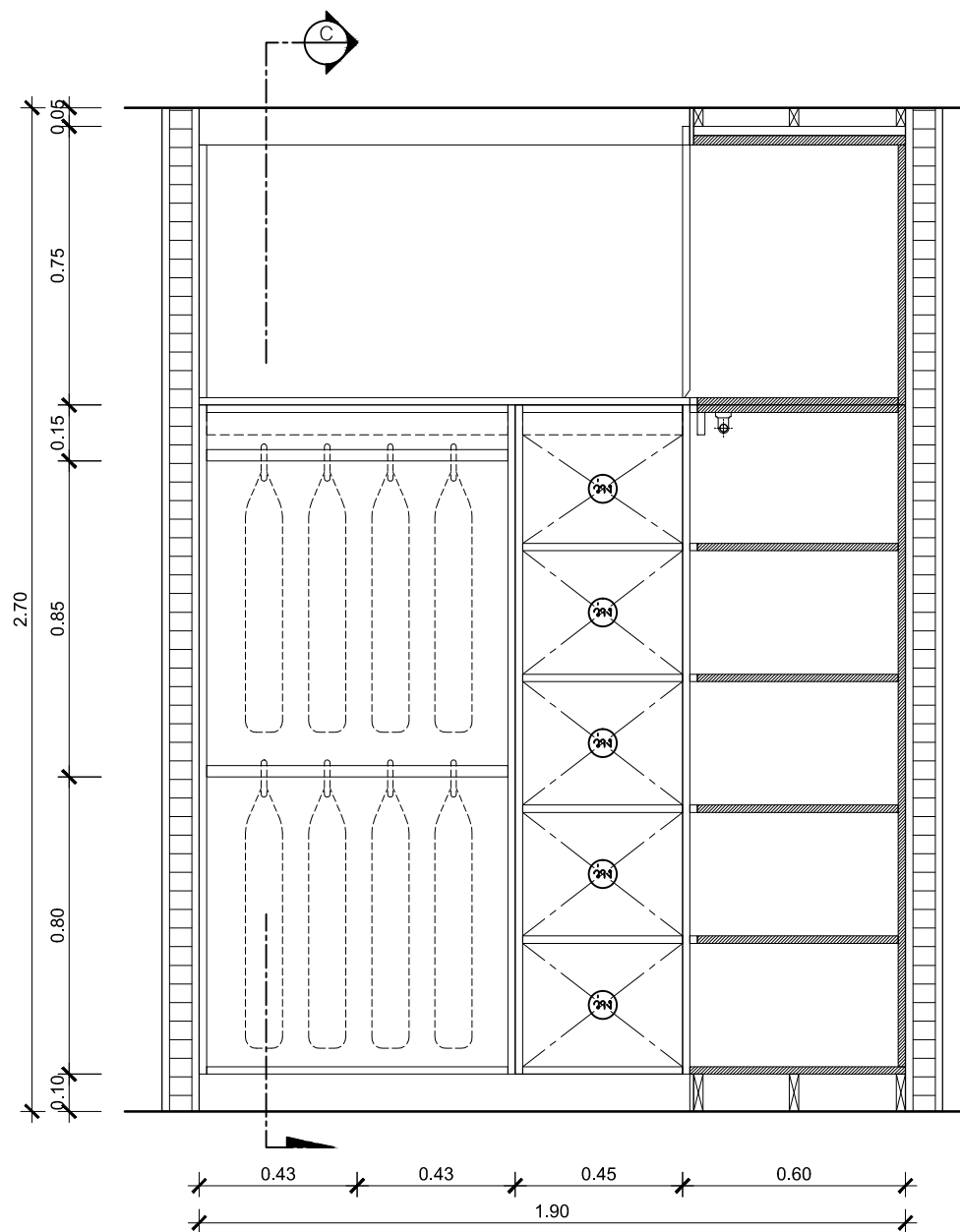

B4-04 ELEVATION (INSIDE)
SCALE 1:20

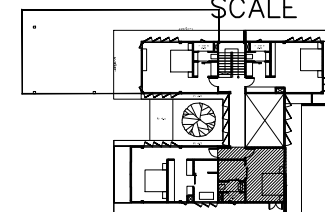

BEDROOM 4 B4-04
SCALE 1:20

P.WE.
[PLAY WITH EVERYTHING]
DESIGN HOUSE

PROJECT NAME:

- house

OWNER:

PROJECT DIRECTOR

P.WE.
[PLAY WITH EVERYTHING]
DESIGN HOUSE

ARCHITECTS

เขมจิรา ณ นคร
ภ-สถ 16584

INTERIOR DESIGNER

STRUCTURAL ENGINEERS

นฤตย์พงษ์ เรืองวัฒนานนท์
ภย.55929

ELECTRICAL ENGINEERS

SANITARY ENGINEERS

PROJECT MANAGER

REVISION

REV.	DATE	REVISION RECORD
01	26/06/2016	

DRAWING TITLE:

CHECKED BY:

DRAWN BY:
เขมจิรา ณ นคร ภ-สถ 16584

SCALE: 1:20 DATE: 10/08/2016

DRAWING NO. A-07 TOTAL

-This drawing shall not be used for construction unless signed "approved".

P.WE.

[PLAY WITH EVERYTHING]
DESIGN HOUSE

PROJECT NAME:

- house

OWNER:

PROJECT DIRECTOR

P.WE.

[PLAY WITH EVERYTHING]
DESIGN HOUSE

ARCHITECTS

เขมจิรา ณ นคร
ภ-สถ 16584

INTERIOR DESIGNER

STRUCTURAL ENGINEERS

นฤตย์พงษ์ เรืองวัฒนานนท์
ภย.55929
ELECTRICAL ENGINEERS

SANITARY ENGINEERS

PROJECT MANAGER

REVISION

REV.	DATE	REVISION RECORD
01	26/06/2016	

DRAWING TITLE:

CHECKED BY:

DRAWN BY:
เขมจิรา ณ นคร ภ-สถ 16584

SCALE: 1 : 20 DATE: 10/08/2016

DRAWING NO. A-07 TOTAL

-This drawing shall not be used for construction unless signed "approved".

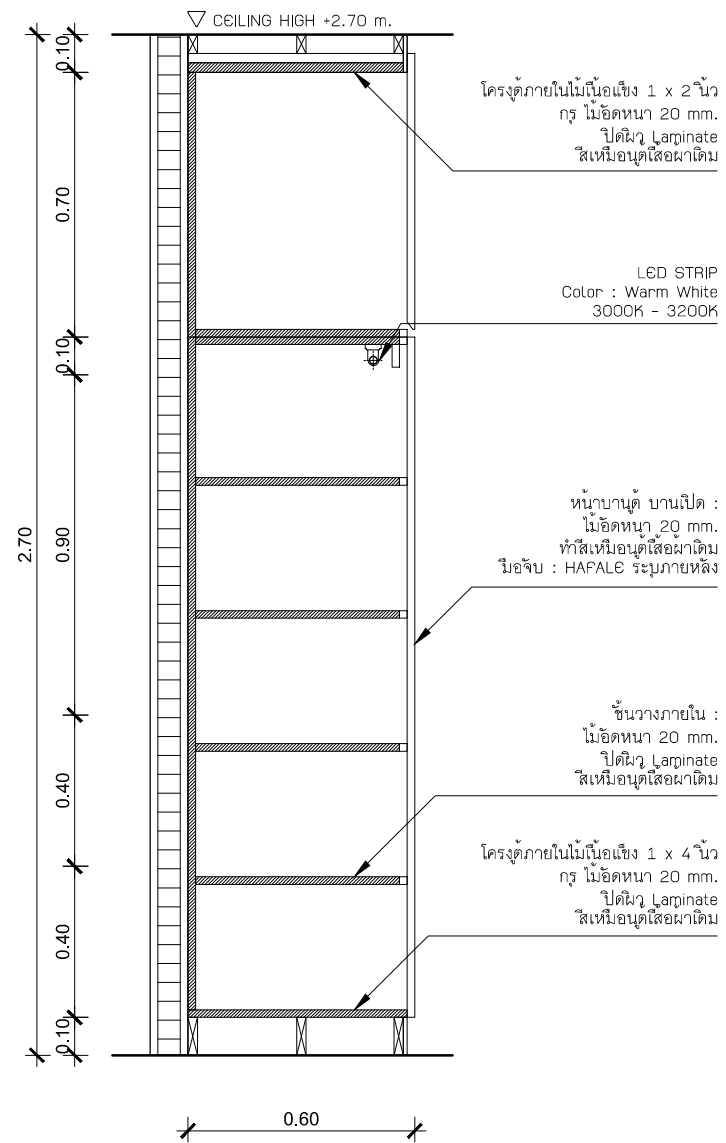

B4-04 SECTION A
SCALE 1:20

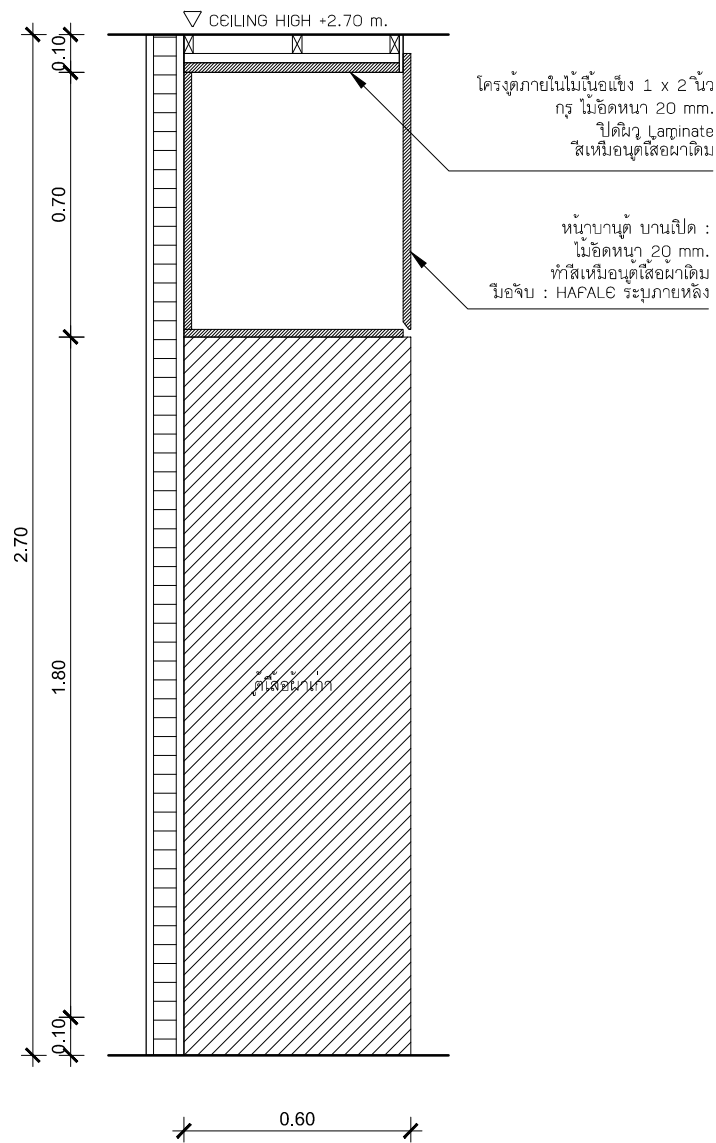

B4-04 SECTION B
SCALE 1:20

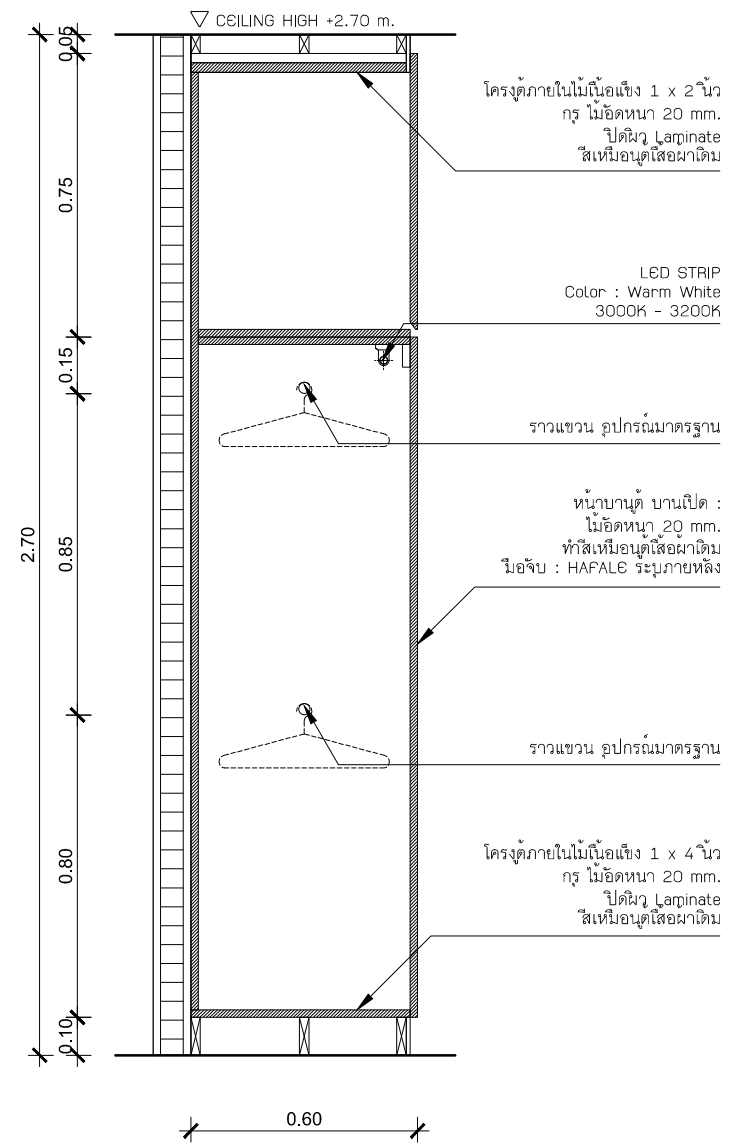

B4-04 SECTION C
SCALE 1:20

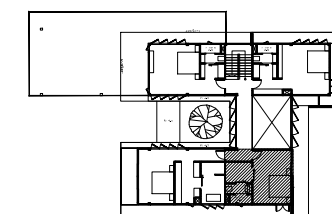

BEDROOM 4 B4-04
SCALE 1:20

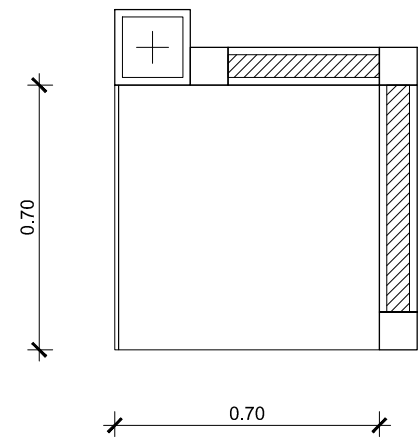

B4-07 PLAN
SCALE 1:20

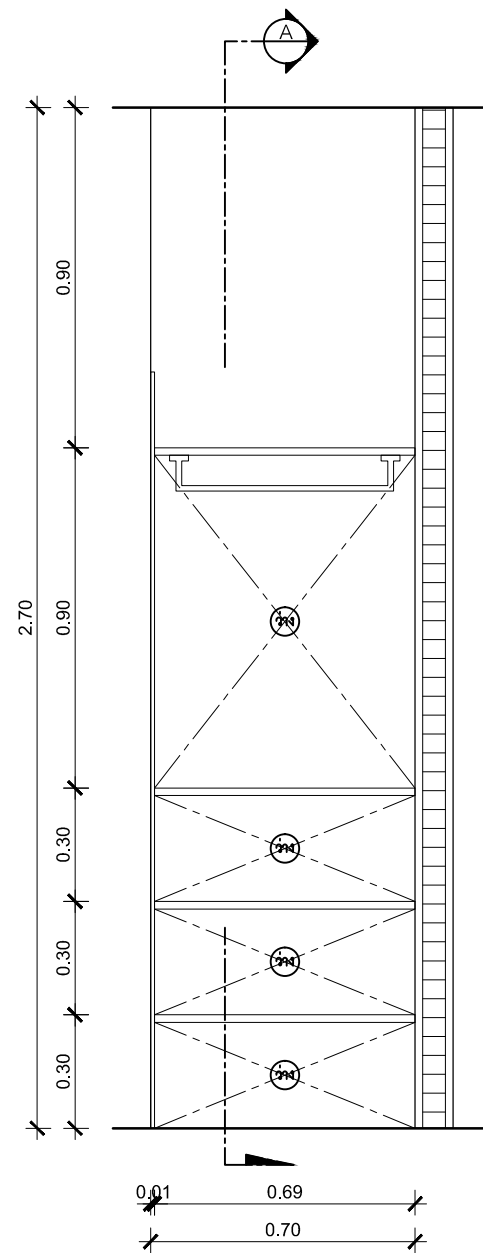

B4-07 ELEVATION
SCALE 1:20

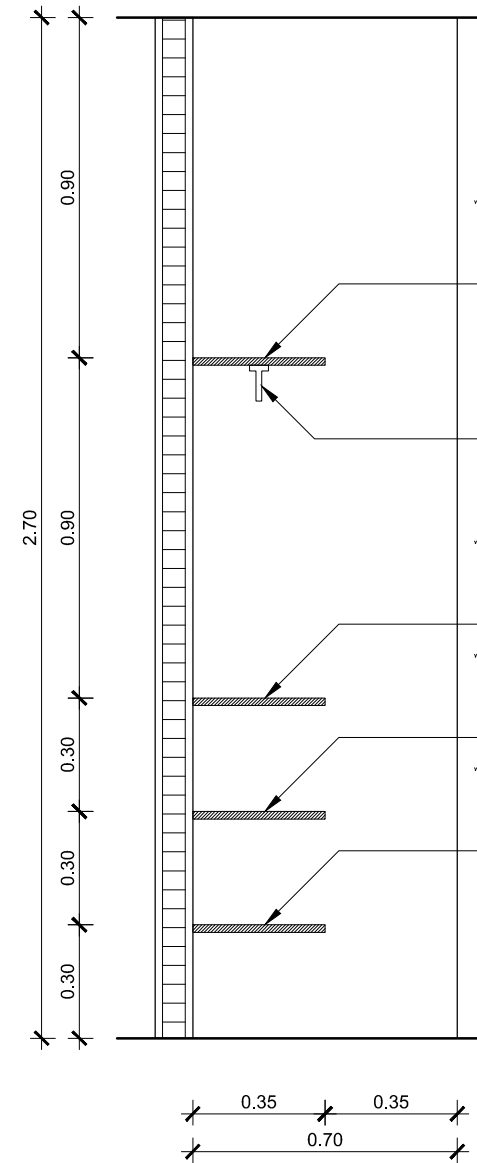

B4-07 SECTION A
SCALE 1:20

ชั้นวาง :
ไม้อัดยางกันความชื้น หน้า 20 mm.
ปิดผิว Laminate
Lamitak : WY1270D
Karla Tivoli Elm

ราวแขวนผ้าใช้ติด
COTTO : CTO222 (HM)
ขนาดความยาว 60 cm.

ชั้นวาง :
ไม้อัดยางกันความชื้น หน้า 20 mm.
ปิดผิว Laminate
Lamitak : WY1270D
Karla Tivoli Elm

ชั้นวาง :
ไม้อัดยางกันความชื้น หน้า 20 mm.
ปิดผิว Laminate
Lamitak : WY1270D
Karla Tivoli Elm

ชั้นวาง :
ไม้อัดยางกันความชื้น หน้า 20 mm.
ปิดผิว Laminate
Lamitak : WY1270D
Karla Tivoli Elm



Lamitak
WY1270D
Karla Tivoli Elm

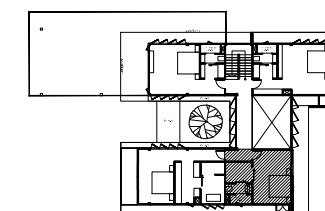

BEDROOM 4
SCALE

B4-07
SCALE 1:20

P.WE.
[PLAY WITH EVERYTHING]
DESIGN HOUSE

PROJECT NAME:
- house

OWNER:

PROJECT DIRECTOR

P.WE.
[PLAY WITH EVERYTHING]
DESIGN HOUSE

ARCHITECTS

เขมจิรา ณ นคร
ภ-สถ 16584

INTERIOR DESIGNER

STRUCTURAL ENGINEERS

นฤตย์พงษ์ เรืองวัฒนานนท์
ภย.55929

ELECTRICAL ENGINEERS

SANITARY ENGINEERS

PROJECT MANAGER

REVISION

REV.	DATE	REVISION RECORD
01	26/06/2016	

DRAWING TITLE:

CHECKED BY:

DRAWN BY:
เขมจิรา ณ นคร ภ-สถ 16584

SCALE: 1:20 DATE: 10/08/2016

DRAWING NO. A-07 TOTAL

-This drawing shall not be used for construction unless signed "approved".

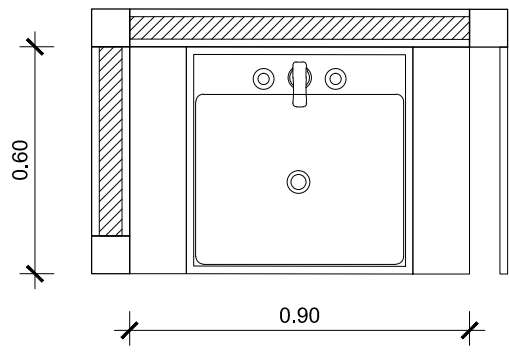

B4-06 PLAN
SCALE 1:20



Lamitak
WY1270D
Karla Tivoli Elm

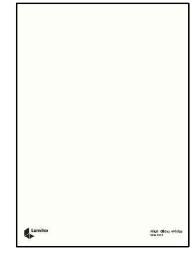

Lamitak
SHG1091
High Gloss White

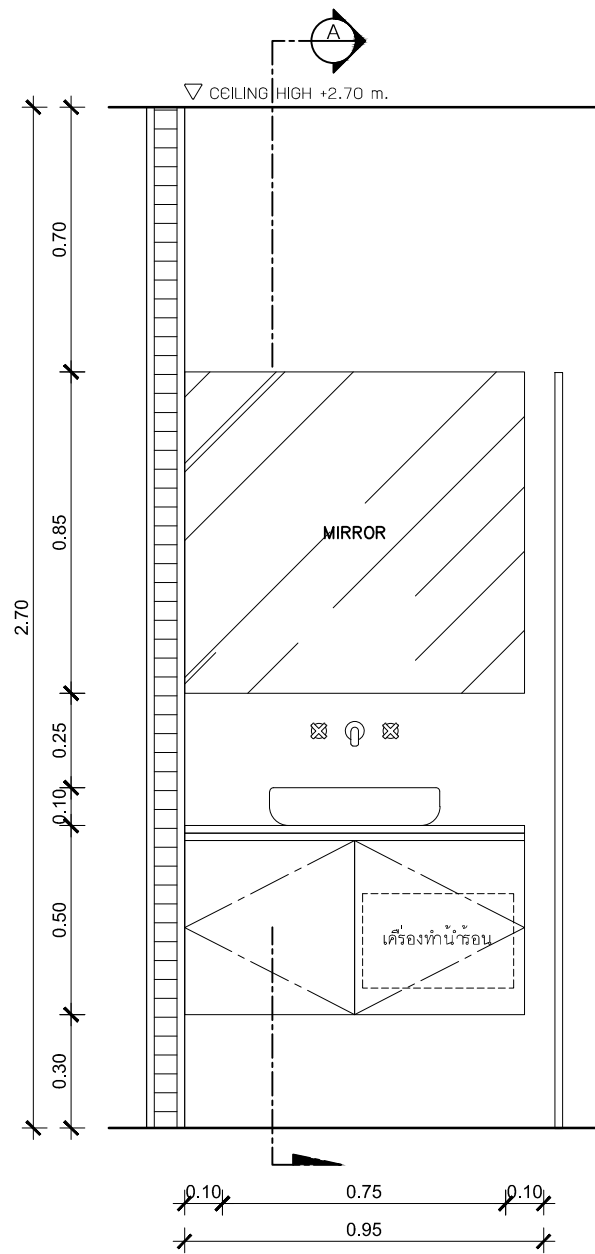

B4-06 ELEVATION
SCALE 1:20

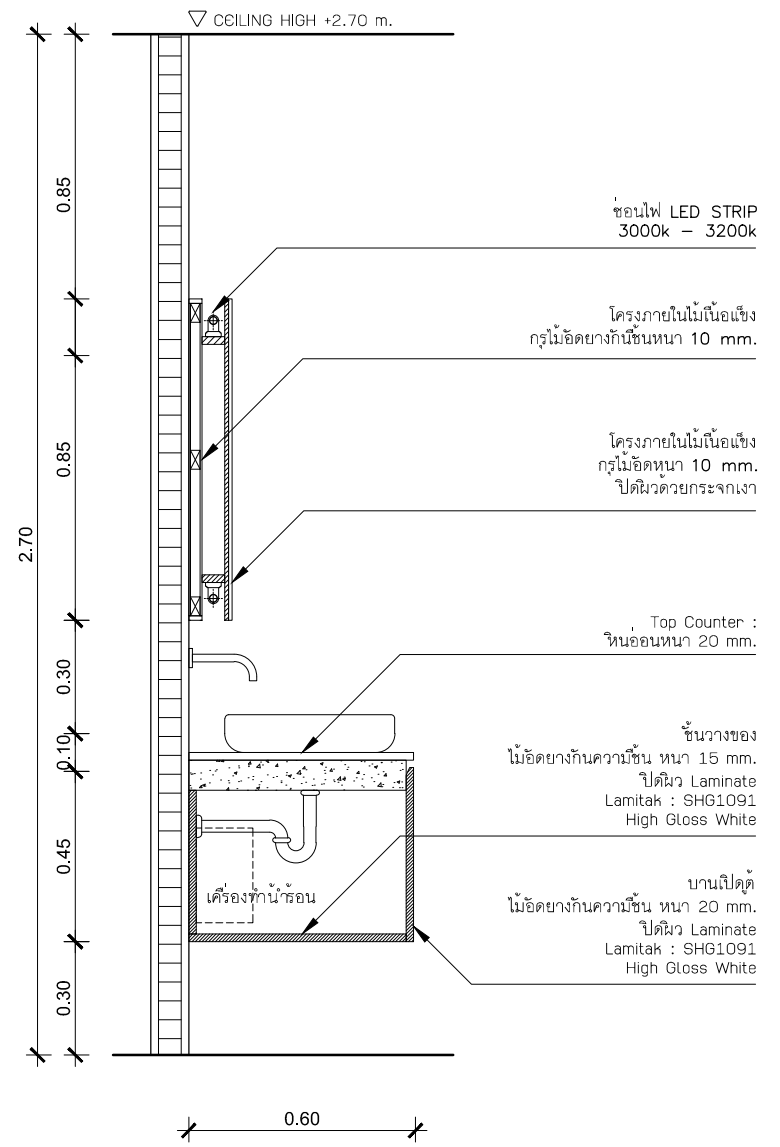

B4-06 SECTION A
SCALE 1:20

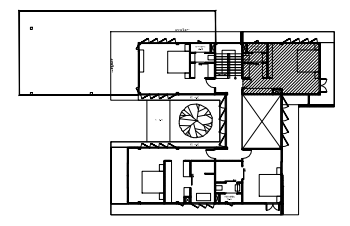

BEDROOM 4 B4-06
SCALE 1:20

P.WE.
[PLAY WITH EVERYTHING]
DESIGN HOUSE

PROJECT NAME:
- house

OWNER:

PROJECT DIRECTOR

P.WE.
[PLAY WITH EVERYTHING]
DESIGN HOUSE

ARCHITECTS

เขมจิรา ณ นคร
ภ-สถ 16584

INTERIOR DESIGNER

STRUCTURAL ENGINEERS

นฤตย์พงษ์ เรืองวัฒนานนท์
ภย.55929
ELECTRICAL ENGINEERS

SANITARY ENGINEERS

PROJECT MANAGER

REVISION

REV.	DATE	REVISION RECORD
01	26/06/2016	

DRAWING TITLE:

CHECKED BY:

DRAWN BY:
เขมจิรา ณ นคร ภ-สถ 16584

SCALE: 1:20 DATE: 10/08/2016

DRAWING NO. A-07 TOTAL

-This drawing shall not be used for construction unless signed "approved".